



D-Line[®]
Trade



Cable Management

Where time, safety and appearance matter

About D-Line	3
About D-Line Trunking	4
Trunking Features & Benefits	5
Trunking Case Study	6
Specifying D-Line Trunking & Safe-D Clips	7
Micro Trunking - 16mm x 8mm	8
Micro+ Trunking - 20mm x 10mm	9
Mini Trunking - 30mm x 15mm	10
Mini+ Trunking - 40mm x 20mm	11
Maxi Trunking - 50mm x 25mm	12
Maxi+ Trunking - 60mm x 30mm	13
¼-Round Trunking - 22mm x 22mm	14
¼-Round Trunking - 30mm x 30mm	15
Surface Boxes	16
Accessories	18
Accessories Fitting Guide	21
Trunking & Accessories Product Codes	22
Trunking Guide	24
Accessories Guide	25
About Safe-D Clips	26
Safe-D Clips Features and Benefits	27
Safe-D 30 Fire Rated Clips	28
Safe-D 30 Fire Rated Red Clips	29
Safe-D 40 Fire Rated Clips	30
Safe-D 50 Fire Rated Clips	31
About Cable Safety Products	32
CC-1 Light Duty Floor Protector	33
FC68B Medium Duty Floor Protector	34
FC83B Medium Duty Floor Protector	35
FC83H Medium Duty Floor Protector	36
FC83B/2C/9M Medium Duty Floor Protector	37
CGS3B Cable Grip Strip	38
DO-1B765 Rigid Single Channel Cable Protector	39
DO-2B765 Rigid Single Channel Cable Protector	40
DO-3BR920 Heavy Duty Cable Protector	41
DX-5RB910 Heavy Duty Cable Protector	42
DX-3RB910 Heavy Duty Cable Protector	43
Socket Enclosures - Large	44
Socket Enclosures - Small	45
Cable Tidy Zipper	46
Split Cable Tube	47
Cable Spiral Wrap	48
Cable Tidy Bases	49
Cable Tidy Clips	50
Cable Tidy Band	51
Cable Tidy Twists	52
About Speed-D Clamps	53
Speed-D Clamp - 6 Port	54
Speed-D Clamp - 12 Port	55





About D-Line

D-Line is a UK company, based in Newcastle upon Tyne, with a global reputation for innovative cable management products 'for use where time, safety and appearance matter'.

In 2004 D-Line patented the world's fastest trunking system, in subtle shapes to blend with modern decor. These iconic D-shaped ½-round & ¼-round profiles are now popular in 25+ countries. As often said 'the finishing touch of a D-Line installation creates a lasting impression'; preferred by specifiers, installers and clients.

In 2009 D-Line also invented the first fire-rated clips that could be fitted in non-metallic trunking, so preventing the potentially fatal consequences of cable entanglement.

In 2010 D-Line developed Socket Enclosures to contain socket extensions and cable clutter, and in 2014 pioneered linkable Floor Cable Protectors to satisfy another common requirement.

In 2016 D-Line launched The Cable Safety at Work Campaign - advising of cable-hazards, legislative responsibilities, and preventive product solutions to reduce accidents and to address Health & Safety cable-risks in workplaces.

In keeping with the company's policy of continuous innovation, Speed-D Clamps can uniquely maintain the order of network cables in server cabinets.

D-Line products are manufactured in the UK to most exacting standards. They are fully tested and certified to highest quality requirements.

“ D-Line trunking is our preferred way to route cables... compared to chasing walls, or standard mini-trunking, it makes a better choice all round! ”



The modern way to hide cables...



About D-Line Trunking

The World's Fastest Trunking System

D-shaped and linear, D-Line is named after the iconic style of our first products. The single-piece design, complementary accessories and subtle shapes combine so that D-Line trunking is 'quick to install and looks great!'

Compared to channelling walls or lifting floors to contain cables, D-Line appreciate how surface trunking installations can save huge amounts of time and cost, while minimising inconvenience; and thereafter protect cables for on-going peace of mind.

It follows that D-Line trunking is an inexpensive and practical alternative to **either** channelling walls **or** traditional trunking products.

At D-Line we respect also that for I.T. and Datacoms, electrical upgrades, Fire & Security, and many HVAC









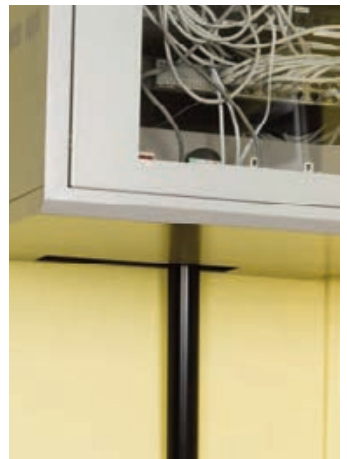

and Audio Visual projects, the equipment will often be the most costly expenditure, but, for a surface installation, the trunking will usually be the most conspicuous element...

D-Line enables a quality of finish to complement the interior design of modern spaces, in stylish ways that are obvious to all stakeholders. As often said using D-Line cable trunking 'cables seem to disappear' and 'the finishing touch of a D-Line cable management installation makes a lasting impression.'

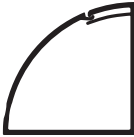
Choose from eight profiles according to the volume of cables to be contained. A choice of colours and full ranges of accessories are available also.

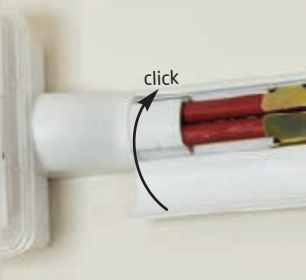
The modern way to hide cables...



	FEATURE	BENEFIT
	Designer shapes and colours	<ul style="list-style-type: none"> • Designs give subtle appearance with no sharp edges; to blend with contemporary surrounds - or colour options to provide a striking feature!
		<ul style="list-style-type: none"> • Alternative sizes satisfy popular demands Available as (width x height) 16x8mm, 20x10mm, 30x15mm, 40x20mm, 50x25mm & 60x30mm • Gentle on impact and easy to clean
		<ul style="list-style-type: none"> • Available (width x height) 22x22mm & 30x30mm • 22x22mm makes the ultimate floor trim! • Can also be used as cornice or coving
	PVC	<ul style="list-style-type: none"> • Self extinguishing • UV stabilised • Lightweight & easy to cut • Stable between -30°C to +60°C • Satisfies BS EN 50085-1:2005
	Patented hinge & click-lock lid	<ul style="list-style-type: none"> • Single-piece design... for quick & easy handling • Only one cut (no need to separately cut base, and lid, before fitting accessories) • Lids will never peel or detach - maintenance friendly • Tensioned hinge provides a cable retainer to keep cables in position during installation • Easy to later add or remove cables • User friendly in tight spaces • Hinge acts as a shock absorber on impact
	Film covered lengths	<ul style="list-style-type: none"> • Keeps lengths pristine before installation • Environmentally friendly packaging
	Self-adhesive foam backing	<ul style="list-style-type: none"> • Simply peel & stick - Quick & easy to install • Can be drilled also
	Easy to use Ratchet Cutting Tool	<ul style="list-style-type: none"> • Use to cut up to 40mm wide D-Line Trunking • No dust residue • Quick & clean cutting action
	Paintable	<ul style="list-style-type: none"> • Can blend with any decor



When 20,000 hotel rooms needed to hide cables for new heating controllers, D-Line Mini Trunking proved the perfect choice...

Using D-Line saved a small fortune compared to the cost of channelling the walls, then needing to co-ordinate works to re-plaster and re-decorate.

Aside the noise and disruption, trying to recess the cabling would have put rooms out-of-service. However traditional trunking did not look suitable for a hotel chain with a reputation for comfort and style.

Cables from wall mounted heaters to wall mounted controllers were concealed in D-Line Mini Trunking which blended with the skirting, and, when necessary, up-and-around bedheads.

A cut-length rose up to the heater via a Clip-Over Equal Tee, while Clip-Over Internal Bends made internal corner connections quick and easy. The Flat Bend required was the Smooth-Fit version, as the secure internal tabs were

favoured to eliminate future maintenance concerns, given that this part was most likely to be bumped by guests' baggage.

The ½-round shape of the length rising up to the wall-mounted controller was preferred also for its impact resistance, the lack of sharp edge a distinct benefit (compared to traditional sharp edge trunking).

The D-Line Cutting Tool was used throughout, saving time and leaving no PVC dust residue.

The self-adhesive tape was used to attach the lengths to the walls, with a screw-fixing and plug then inserted 750mm from each end.

The result was 20,000 installations using 200km - all easy to fit, quick to install and blending with decor.

Further details on request.

Unique Clip-Over Accessories

Saves Channelling Walls

Quick and Easy to Fit

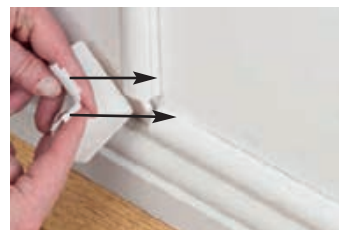



To specify D-Line ½-round Trunking: ½-round Trunking, produced using self-extinguishing PVC with non-detachable hinged & click-lock lid in a single piece design, as compliant with BS EN 50085 - 1:2005 Part 1. Use with proprietary accessories.

To specify Safe-D Clips: High-temperature pliable-steel fire-rated clips with passivated non-corrosive finish, 20mm wide fold-over tabs with rounded top edges to satisfy design requirement BS7671 s522.8.11, and having test certification to confirm compliance with performance requirement BS5839-1. Use with non-combustible fixings suitable for relevant surface.

To fit at 300mm horizontal & 400mm vertical spacings.

Compared to channelling walls, using D-Line Trunking and Safe-D Clips can save up to 70% on installation costs...

- Disruption is minimized (reduced noise and mess)
- Saving need to co-ordinate several trades (e.g. plastering, decorating etc)
- On-going assured cable protection

Compared to other trunking/clip systems, using D-Line Trunking and Safe-D Clips can save up to 33% labour time and costs...

- Single piece design (one piece to handle/cut)
- Simply fit, fix and fold Safe-D Clips to secure cables
- On-going appearance that blends with decor

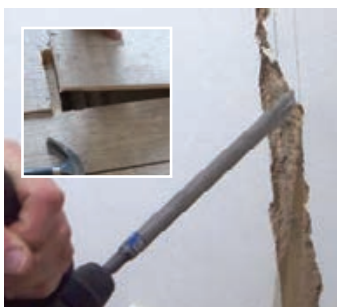

Making channels in walls, lifting floors, or using ceiling voids to hide cables can be awkward and disruptive, while repairs require co-ordination with other trades.



Cables can be vulnerable in cavities e.g. rodents gnawing insulation; careless drilling or nailing - and future access to the installation is most difficult.



Two pieces to handle, awkward to install, lids can detach to create on-going maintenance demands.

Blocky sharp-edged white plastic strips can look unfashionable in modern decor.



Inadequately supported cables pose risk of potentially fatal entanglements in fire conditions.

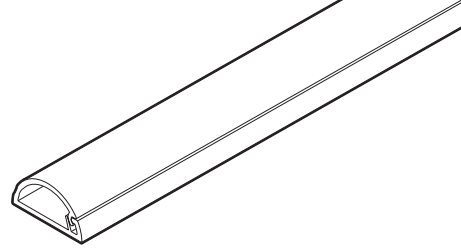

Micro Trunking 16mm x 8mm

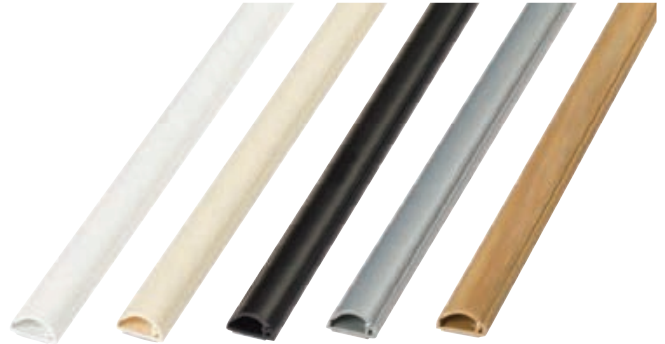

To hide speaker cable, bell wires, telephone and alarm cable, Micro Trunking offers a discreet solution.

Available in a choice of colours and with a range of Smooth-Fit accessories, the 16 x 8mm dimensions give options in the tightest of spaces and can often fit around door frames.

- Micro profile, only 16x8mm (WxH)
- Patented hinge & click-lock lid
- Paintable
- Smooth-Fit accessories available for perfect finish
- 'Easy to install, looks great!'
- Self-adhesive
- Fully safety tested and certified to BS EN 50085-1:2005

Code	Description	Colour
R2D1608W	(L) 2m x (W) 16mm x (H) 8mm	White
R3D1608W	(L) 3m x (W) 16mm x (H) 8mm	White
R2D1608M	(L) 2m x (W) 16mm x (H) 8mm	Magnolia
R2D1608A	(L) 2m x (W) 16mm x (H) 8mm	Aluminium Effect
R2D1608B	(L) 2m x (W) 16mm x (H) 8mm	Black
R2D1608O	(L) 2m x (W) 16mm x (H) 8mm	Oak Effect

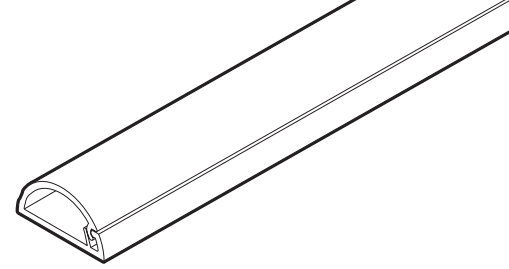

Micro+ Trunking 20mm x 10mm



D-Line 20 x 10mm Micro+ profile gives a neat solution for single cables, while offering additional internal capacity that can be useful around corners.

Complementary Clip-Over bends and tees are incredibly easy to install. Ideal for flexible cables (up to 8mm outer diameter), also fibre-optic, satellite/aerial and broadband cable installations.

- Discreet and stylish appearance; only 20 x 10mm (WxH)
- Patented hinge & click-lock lid
- Paintable
- Clip-Over accessories available for perfect finish
- 'Easy to install, looks great!'
- Self-adhesive
- Fully safety tested and certified to BS EN 50085-1:2005

Code	Description	Colour
R2D2010W	(L) 2m x (W) 20mm x (H) 10mm	White
R3D2010W	(L) 3m x (W) 20mm x (H) 10mm	White

Mini Trunking 30mm x 15mm

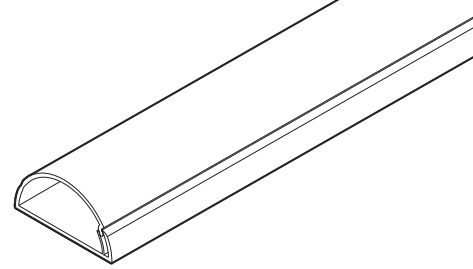

D-Line 30x15mm Mini Trunking offers a subtle appearance to make surface cable installations look attractive! The ½-round shape can blend to resemble the natural top-section of skirting boards, while offering a modern solution for vertical cable drops and runs across ceilings.

Available in a variety of colours that can blend with surrounds or create a striking visual feature. This versatile profile is popular for 2x 2.5mm T&E, 2x 1.5mm 2c FP cables, 2x broadband cable and 4x Cat-5 combinations.

- Unique stylish 'D-Line' appearance
- Patented hinge & click-lock lid
- Self-adhesive
- Paintable
- Clip-Over & Smooth-Fit accessories for perfect finish
- 'Easy to install, looks great!'
- Adaptors enable popular connections [see page 18/19](#)
- Fully safety tested and certified to BS EN 50085-1:2005

Code	Description	Colour
R2D3015W	(L) 2m x (W) 30mm x (H) 15mm	White
R3D3015W	(L) 3m x (W) 30mm x (H) 15mm	White
R2D3015M	(L) 2m x (W) 30mm x (H) 15mm	Magnolia
R3D3015M	(L) 3m x (W) 30mm x (H) 15mm	Magnolia
R2D3015A	(L) 2m x (W) 30mm x (H) 15mm	Aluminium Effect
R3D3015A	(L) 3m x (W) 30mm x (H) 15mm	Aluminium Effect

Code	Description	Colour
R2D3015B	(L) 2m x (W) 30mm x (H) 15mm	Black
R3D3015B	(L) 3m x (W) 30mm x (H) 15mm	Black
R2D3015O	(L) 2m x (W) 30mm x (H) 15mm	Oak Effect
R3D3015O	(L) 3m x (W) 30mm x (H) 15mm	Oak Effect
R3D3015R	(L) 3m x (W) 30mm x (H) 15mm	Red

Mini+ Trunking 40mm x 20mm

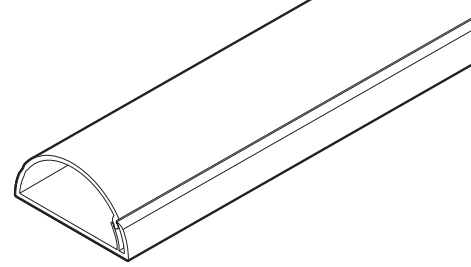

Single Piece Design

D-Line 40 x 20mm Mini+ profile provides capacity ideal for 2x 4mm T&E cables for example.

As applicable to all D-Line lengths, the hinged lid is always attached so future maintenance concerns are minimised.

Available with Smooth-Fit accessories.

- Unique stylish 'D-Line' appearance
- Patented hinge & click-lock lid
- Paintable
- Smooth-Fit accessories available for perfect finish
- 'Easy to install, looks great!'
- Self-adhesive
- Fully safety tested and certified to BS EN 50085-1:2005

Code	Description	Colour
R2D4020W	(L) 2m x (W) 40mm x (H) 20mm	White
R3D4020W	(L) 3m x (W) 40mm x (H) 20mm	White

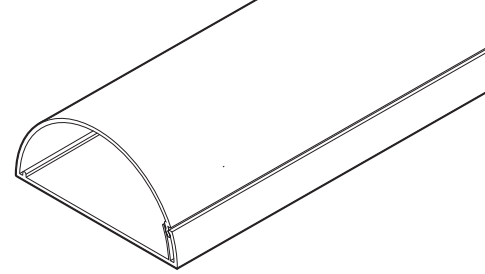

Maxi Trunking 50mm x 25mm

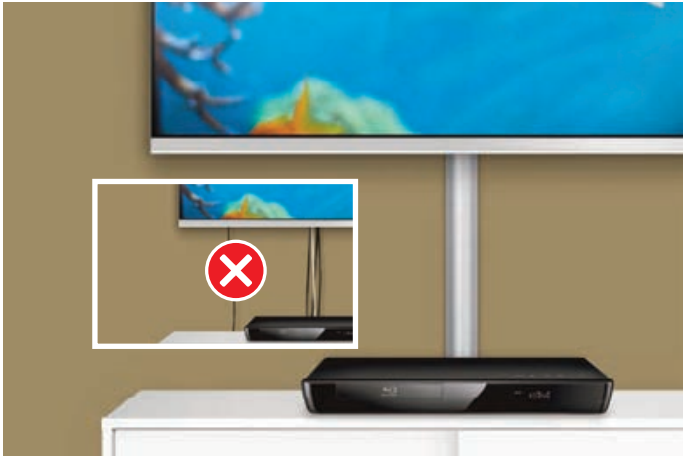

D-Line 50x25mm Maxi is a versatile trunking, providing capacity for several cables.

A wide range of Clip-Over and Smooth-Fit accessories are available.

The size, capacity and range of colours makes this profile a market-leading solution that is ideal for many AV, electrical and datacoms projects.

- Unique stylish 'D-Line' appearance
- Saves channelling walls
- Self-adhesive
- Clip-Over & Smooth-Fit accessories for perfect finish
- A smart alternative to traditional offers
- No sharp edges, gentle on impact
- Fully safety tested and certified to BS EN 50085-1:2005

Code	Description	Colour
R2D5025W	(L) 2m x (W) 50mm x (H) 25mm	White
R3D5025W	(L) 3m x (W) 50mm x (H) 25mm	White
R2D5025M	(L) 2m x (W) 50mm x (H) 25mm	Magnolia
R2D5025A	(L) 2m x (W) 50mm x (H) 25mm	Aluminium Effect
R2D5025B	(L) 2m x (W) 50mm x (H) 25mm	Black
R2D5025O	(L) 2m x (W) 50mm x (H) 25mm	Oak Effect

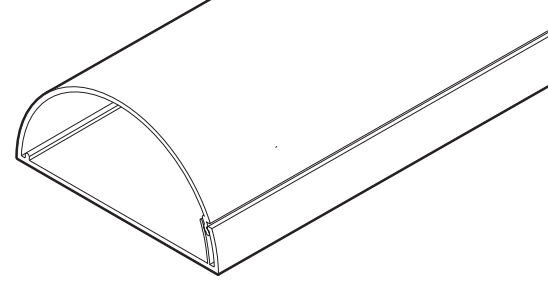

Maxi+ Trunking 60mm x 30mm



D-Line Trunkings make ideal cable organisers for desks



D-Line 60x30mm Maxi+ provides a useful option when extra capacity is required for multiple cables.

60 x 30 mm profiles are popular for containing HDMI and aerial cables dropping from wall mounted TV's... scaling very well for example with 50" + width screens.

The effective adhesive backing can be useful as a fixing guide, then – same as all D-Line trunking – the lengths can be drilled for screw-fixing also.

Available with Smooth-Fit accessories that offer secure fitment, as the male shoulder tabs are secured under the fastened lid.

- Unique stylish 'D-Line' appearance
- Patented hinge & click-lock lid
- Paintable
- Smooth-Fit accessories available for perfect finish
- 'Easy to install, looks great!'
- Self-adhesive
- Fully safety tested and certified to BS EN 50085-1:2005

Code	Description	Colour
R2D6030W	(L) 2m x (W) 60mm x (H) 30mm	White
R3D6030W	(L) 3m x (W) 60mm x (H) 30mm	White
R2D6030M	(L) 2m x (W) 60mm x (H) 30mm	Magnolia
R2D6030A	(L) 2m x (W) 60mm x (H) 30mm	Aluminium Effect
R2D6030B	(L) 2m x (W) 60mm x (H) 30mm	Black

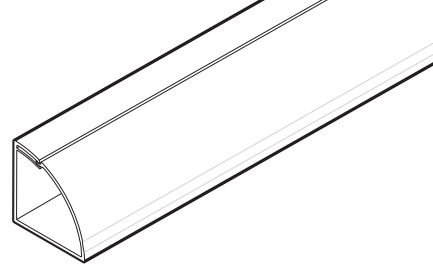

1/4-Round Trunking 22mm x 22mm



1/4-round 22 x 22mm profile covers expansion gaps between floors and skirting. The 22 x 22mm (W x H) dimensions scale well to blend with popular skirting boards, while providing capacity for cable bending radii around corners.

Traditional floor trim is usually nailed, and requires perfect measuring of lengths before corners can be mitre-cut at 45° angles. By contrast D-Line 1/4-round can simply peel-and-stick to skirting, while the Clip-Over corner-bends save any need for precise measuring and can cover oblique cuts.

Compared to regular floor trim, D-Line features combine to enable approximately 50% quicker installations – and then it's easy to add or remove cables!

- Easy to install, looks great!
- Self-adhesive, simply peel & stick to skirting
- Clip-Over or Smooth-Fit corners eliminate the need to mitre-cut
- A smart alternative to traditional floor trims
- Shock-absorbing hinge effect
- A neat cornice option also (see pic above)
- Fully safety tested and certified to BS EN 50085-1:2005

Code	Description	Colour
R2D22QSW	(L) 2m x (W) 22mm x (H) 22mm	White
R3D22QSW	(L) 3m x (W) 22mm x (H) 22mm	White
R2D22QSO	(L) 2m x (W) 22mm x (H) 22mm	Oak Effect
R2D22QSP	(L) 2m x (W) 22mm x (H) 22mm	Stainable Wood
R2D22QSF1	(L) 2m x (W) 22mm x (H) 22mm	Light Oak Effect

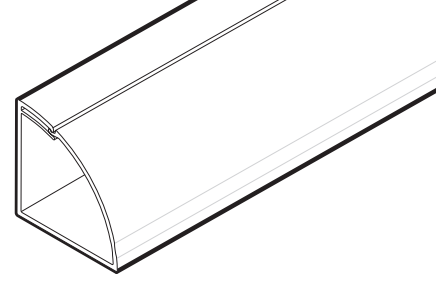

1/4-Round Trunking 30mm x 30mm

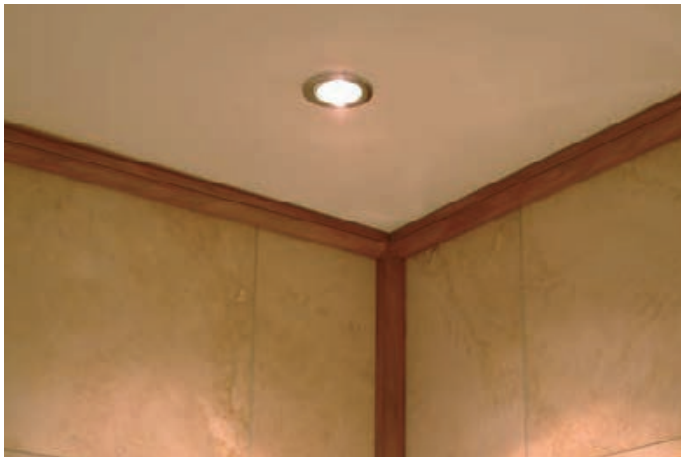

1/4-round 30 x 30mm Trunking is popular for right-angle intersections, and offers additional capacity. This profile is available with Smooth-Fit accessories.

It can be an ideal solution for cornice drops, around benches and can eliminate need for skirting boards in smaller rooms.

The tensioned hinge can act as a shock absorber, useful when installed as a floor trim!

- Unique stylish 'D-Line' appearance
- Saves channelling walls
- Self-adhesive
- Smooth-Fit accessories available for perfect finish
- Shock-absorbing hinge effect
- Fully safety tested and certified to BS EN 50085-1:2005

Code	Description	Colour
R2D30QSW	(L) 2m x (W) 30mm x (H) 30mm	White
R3D30QSW	(L) 3m x (W) 30mm x (H) 30mm	White
R2D30QSM	(L) 2m x (W) 30mm x (H) 30mm	Magnolia
R2D30QSO	(L) 2m x (W) 30mm x (H) 30mm	Oak Effect

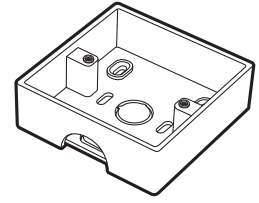

Single Surface Box 28mm & 35mm



All D-Line Surface Boxes have a unique push-out tab, so for a single entry/exit there is no need to create knockouts!

Note the boxes are malleable, to facilitate the making of cut-outs when any additional entries are required.

Conforming to BS4662, and available in a variety of colours, use with Box Adaptors or Box Adaptor Tees to enable connections in line between vertical and horizontal installations. Please see [page 19](#).

For network outlets and break glass installations requiring additional capacity, 35mm depth white and red surface boxes are available also.



35mm Deep Standard Corner Boxes

Code	Description	Colour
SSB35W	(L) 87mm x (W) 87mm x (H) 35mm	White
SSB35R	(L) 87mm x (W) 87mm x (H) 35mm	Red

Rounded Corner Boxes

Code	Description	Colour
SSB28RW	(L) 87mm x (W) 87mm x (H) 28mm	White
SSB35RW	(L) 87mm x (W) 87mm x (H) 35mm	White

28mm Deep Standard Corner Boxes

Code	Description	Colour
SSB28W	(L) 87mm x (W) 87mm x (H) 28mm	White
SSB28A	(L) 87mm x (W) 87mm x (H) 28mm	Aluminium
SSB28B	(L) 87mm x (W) 87mm x (H) 28mm	Black
SSB28M	(L) 87mm x (W) 87mm x (H) 28mm	Magnolia
SSB28O	(L) 87mm x (W) 87mm x (H) 28mm	Oak

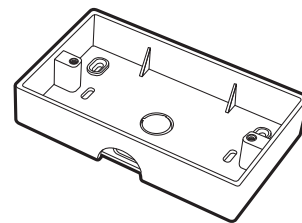

Twin Surface Box 28mm & 35mm



* All surface boxes supplied c/w push out tabs



All D-Line twin two-gang Surface Boxes have push-out tabs, so for a single entry/exit there is no need to create knockouts!

Same as single versions, these boxes are malleable so it can be easy to make any additional entries required.

Use with Box Adaptors — or Box Adaptor Tees to connect in line between vertical and horizontal installations; 30 x 15mm, 40 x 20mm, and 50 x 25mm ½-round, and 30 x 30mm ¼-round trunking, can all connect to D-Line Surface Boxes using Box Adaptor Tees.

- For UK specification surface-mounted two-gang sockets
- Push-out tab to create clean and perfect knock-out
- Can accept D-Line Box Adaptor and Box Adaptor Tee accessories
- Malleable, not brittle
- Easy to drill alternative/additional entry points
- Fully safety tested and certified to BS 4662:2006+A1:2009

28mm Deep Standard Corner Boxes

Code	Description	Colour
TSB28W	(L) 147mm x (W) 87mm x (H) 28mm	White
TSB28A	(L) 147mm x (W) 87mm x (H) 28mm	Aluminium
TSB28B	(L) 147mm x (W) 87mm x (H) 28mm	Black
TSB28M	(L) 147mm x (W) 87mm x (H) 28mm	Magnolia
TSB28O	(L) 147mm x (W) 87mm x (H) 28mm	Oak

35mm Deep Standard Corner Boxes

Code	Description	Colour
TSB35W	(L) 147mm x (W) 87mm x (H) 35mm	White

Rounded Corner Boxes

Code	Description	Colour
TSB28RW	(L) 147mm x (W) 87mm x (H) 28mm	White
TSB35RW	(L) 147mm x (W) 87mm x (H) 35mm	White

Pattress Adaptor

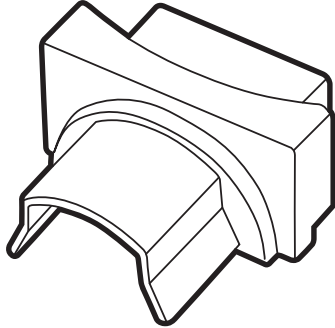

The Pattress Adaptor has internal ½-round shoulders which enable secure fitment under the click-lock lid of 30 x 15mm ½-round profiles, while the internal rectangular shoulders at opposite end can be positively retained in any 25 x 16mm knockouts.

The protruding flange is rounded to complement the circumference of popular circular pattress bases and ceiling roses.

- Connect 30 x 15mm Mini Trunking to round surface pattresses

Circular Adaptor

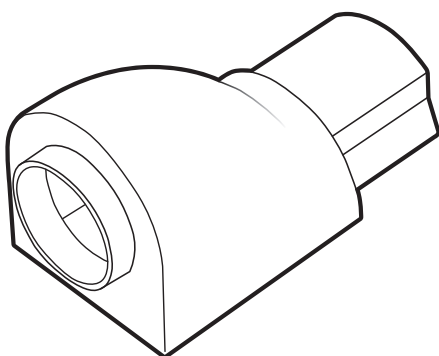

Circular Adaptors make a neat interface between 30 x 15mm Mini Trunking and flat surfaces with 20mm diameter knockouts.

Male shoulders give a secure connection inside 30 x 15mm Mini Trunking, while installers can make a 20mm diameter hole for the circular flange to sit inside. Popular for example to fit up to surface luminaires, flat-sided enclosures, and to contain 2x 1.5mm 2c FP cables dropping to break glass units.

- Connect 30 x 15mm Mini Trunking to flat surfaces with 20mm diameter knockouts

Flat Adaptor

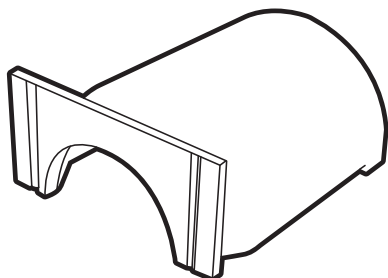

Flat Adaptors clip over ends of 30 x 15mm Mini Trunking and have a flange cover to neatly cover cut-outs (< 30 x 15mm) on a flat edge.

They save the need for precise notching, and enable cables to be neatly routed through a flat surface and into 30 x 15mm ½-round D-Line Mini Trunking profiles.

The flange can fit 34 x 17mm apertures, or can easily be cut to fit 25 x 16mm knock-outs.



The Flat Adaptor can interface with traditional flat-edge trunkings in cornice and coving applications; with the flat-edged accessories of popular coving trunkings; and some flat-edged pattress bases also – for example breaking-out to D-Line 30 x 15mm across ceilings or vertical runs to switch/socket drops, where the ½ round appearance gives a smart solution with uniquely subtle aesthetics.

- Connect 30 x 15mm Mini Trunking lengths to flat-faced surfaces

Box Adaptor

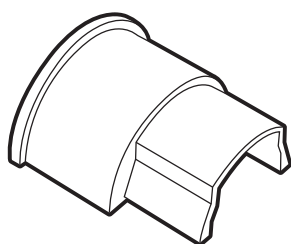

Box Adaptors have internal shoulders which securely fit into 30 x 15mm Mini Trunking. The circular flange locks into the 30 x 15mm ½-round cut out on D-Line surface boxes.

- For use between 30 x 15mm Mini Trunking and D-Line Surface Boxes

Box Adaptor Tee

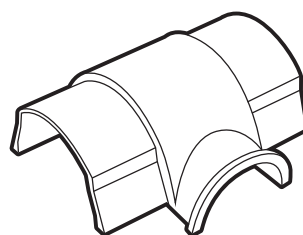

Box Adaptor Tees connect 2 lengths of same size trunking on a straight horizontal or vertical run, and have a rounded top-flange which can lock into the pre-formed cut-out of D-Line Surface Boxes.

- For use with D-Line Surface Boxes
- Available for 30 x 15mm, 40 x 20mm, 50 x 25mm ½-round and 30 x 30mm ¼-round trunkings
- Clip-Over version for 50 x 25mm is also available

*The modern way to hide cables
where time, safety and appearance matter!*



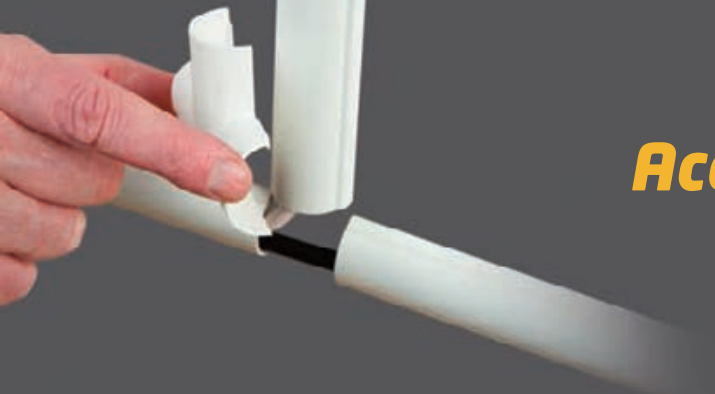

Accessories Fitting Guide

Clip-Over Accessories - for 1/2-round 20x10mm, 30x15mm, 50x25mm profiles & 22x22mm 1/4-round only

Design forgives rough or oblique cuts, and imprecise measuring.

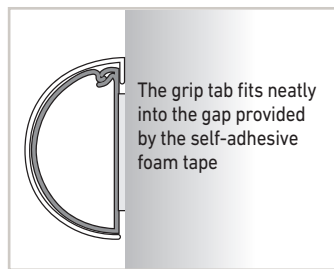
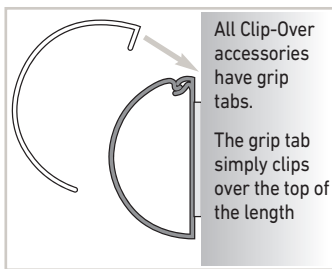

Smooth-Fit Accessories - for 1/2-round 16x8mm, 40x20mm, 60x30mm, & 30x30mm 1/4-round profiles Also available for 30x15mm, 50x25mm 1/2-round, & 22x22mm 1/4-round profiles

Internal shoulders fit securely under lengths.

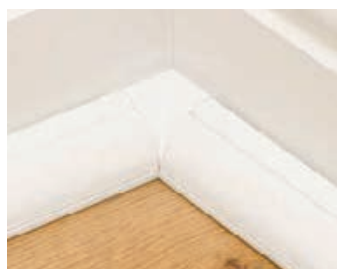



1/2-Round 16 x 8mm Micro Trunking

		White	Magnolia	Aluminium Effect	Black	Oak Effect
Lengths	3.0m Length	R3D1608W	-	-	-	-
	2.0m Length	R2D1608W	R2D1608M	R2D1608A	R2D1608B	R2D1608O
Accessories	Smooth-Fit Internal Bend	IB1608W	IB1608M	IB1608A	IB1608B	IB1608O
	Smooth-Fit External Bend	EB1608W	EB1608M	EB1608A	EB1608B	EB1608O
	Smooth-Fit Flat Bend	FB1608W	FB1608M	FB1608A	FB1608B	FB1608O
	Smooth-Fit Equal Tee	NET1608W	NET1608M	NET1608A	NET1608B	NET1608O
	Smooth-Fit Coupler	NCP1608W	NCP1608M	NCP1608A	NCP1608B	NCP1608O
	Smooth-Fit End Cap	EC1608W	EC1608M	EC1608A	EC1608B	EC1608O



1/2-Round 20 x 10mm Micro+ Trunking

		White
Lengths	3.0m Length	R3D2010W
	2.0m Length	R2D2010W
Clip-Over Accessories	Clip-Over Internal Bend	FLIB2010W
	Clip-Over External Bend	FLEB2010W
	Clip-Over Flat Bend	FLFB2010W
	Clip-Over Equal Tee	FLET2010W
Smooth-Fit Accessories	Smooth-Fit Coupler	CP2010W
	Smooth-Fit End Cap	EC2010W



1/2-Round 40 x 20mm Mini+ Trunking

		White
Lengths	3.0m Length	R3D4020W
	2.0m Length	R2D4020W
Accessories	Smooth-Fit Internal Bend	IB4020W
	Smooth-Fit External Bend	EB4020W
	Smooth-Fit Flat Bend	FB4020W
	Smooth-Fit Equal Tee	ET4020W
	Smooth-Fit Coupler	CP4020W
	Smooth-Fit End Cap	EC4020W
	Smooth-Fit Box Adaptor Tee	AT4020W



1/2-Round 30 x 15mm Mini Trunking

		White	Magnolia	Aluminium Effect	Black	Oak Effect	Red
Lengths	3.0m Length	R3D3015W	R3D3015M	R3D3015A	R3D3015B	R3D3015O	R3D3015R
	2.0m Length	R2D3015W	R2D3015M	R2D3015A	R2D3015B	R2D3015O	-
	3.0m Self Adhesive Internal Divider	3AD3015L	-	-	-	-	-
Clip-Over Accessories	Clip-Over Internal Bend	FLIB3015W	FLIB3015M	FLIB3015A	FLIB3015B	FLIB3015O	FLIB3015R
	Clip-Over External Bend	FLEB3015W	FLEB3015M	FLEB3015A	FLEB3015B	FLEB3015O	FLEB3015R
	Clip-Over Flat Bend	FLFB3015W	FLFB3015M	FLFB3015A	FLFB3015B	FLFB3015O	FLFB3015R
	Clip-Over Door Top Bend	FLDB3015W	FLDB3015M	FLDB3015A	FLDB3015B	FLDB3015O	FLDB3015R
	Clip-Over Equal Tee	FLET3015W	FLET3015M	FLET3015A	FLET3015B	FLET3015O	FLET3015R
	Clip-Over Flat Adaptor	FA3015W	-	-	-	-	FA3015R
Smooth-Fit Accessories	Smooth-Fit Internal Bend	IB3015W	IB3015M	IB3015A	IB3015B	IB3015O	IB3015R
	Smooth-Fit External Bend	EB3015W	EB3015M	EB3015A	EB3015B	EB3015O	EB3015R
	Smooth-Fit Flat Bend	FB3015W	FB3015M	FB3015A	FB3015B	FB3015O	FB3015R
	Smooth-Fit Equal Tee	ET3015W	ET3015M	ET3015A	ET3015B	ET3015O	ET3015R
	Smooth-Fit Cable Outlet	CO3015W	CO3015M	CO3015A	CO3015B	CO3015O	-
	Smooth-Fit Coupler	CP3015W	CP3015M	CP3015A	CP3015B	CP3015O	CP3015R
	Smooth-Fit End Cap	EC3015W	EC3015M	EC3015A	EC3015B	EC3015O	EC3015R
	Smooth-Fit Pattress Adaptor	PA3015W	-	-	-	-	-
	Smooth-Fit Circular Adaptor	CA3015W	-	-	-	-	CA3015R
	Smooth-Fit Box Adaptor	BA3015W	BA3015M	BA3015A	BA3015B	BA3015O	BA3015R
	Smooth-Fit Box Adaptor Tee	AT3015W	AT3015M	AT3015A	AT3015B	AT3015O	-



1/2-Round 50 x 25mm TV Trunking

		White	Magnolia	Aluminium Effect	Black	Oak Effect
Lengths	3.0m Length	R3D5025W	-	-	-	-
	2.0m Length	R2D5025W	R2D5025M	R2D5025A	R2D5025B	R2D5025O
	3.0m Self Adhesive Internal Divider	3AD5025L	-	-	-	-
Clip-Over Accessories	Clip-Over Internal Bend	FLIB5025W	FLIB5025M	FLIB5025A	FLIB5025B	FLIB5025O
	Clip-Over External Bend	FLEB5025W	FLEB5025M	FLEB5025A	FLEB5025B	FLEB5025O
	Clip-Over Flat Bend	FLFB5025W	FLFB5025M	FLFB5025A	FLFB5025B	FLFB5025O
	Clip-Over Equal Tee	FLET5025W	FLET5025M	FLET5025A	FLET5025B	FLET5025O
	Clip-Over Box Adaptor Tee	FLAT5025W	FLAT5025M	FLAT5025A	FLAT5025B	FLAT5025O
Smooth-Fit Accessories	Smooth-Fit Internal Bend	IB5025W	IB5025M	IB5025A	IB5025B	IB5025O
	Smooth-Fit External Bend	EB5025W	EB5025M	EB5025A	EB5025B	EB5025O
	Smooth-Fit Flat Bend	FB5025W	FB5025M	FB5025A	FB5025B	FB5025O
	Smooth-Fit Equal Tee	ET5025W	ET5025M	ET5025A	ET5025B	ET5025O
	Smooth-Fit Coupler	CP5025W	CP5025M	CP5025A	CP5025B	CP5025O
	Smooth-Fit End Cap	EC5025W	EC5025M	EC5025A	EC5025B	EC5025O
	Smooth-Fit Reducing Tee (to 30x15mm)	RT5030W	RT5030M	RT5030A	RT5030B	RT5030O
	Smooth-Fit Box Adaptor Tee	AT5025W	AT5025M	AT5025A	AT5025B	AT5025O
10mm Pipe Accessories	Twin 10mm Pipe-Clip Bend	DPP10	-	-	-	-
	Single 10mm Pipe-Clip Bend	SPB10	-	-	-	-
	10mm Pipe Exit End Cap	ECS5025W	-	-	-	-
	10mm Twin Pipe Clip	10PR52	-	-	-	-



1/2-Round 60 x 30mm Trunking

		White	Magnolia	Aluminium Effect	Black
Lengths	3.0m Length	R3D6030W	-	-	-
	2.0m Length	R2D6030W	R2D6030M	R2D6030A	R2D6030B
	3.0m Self Adhesive Internal Divider	3AD6030L	-	-	-
Smooth Fit Accessories	Smooth-Fit Internal Bend	IB6030W	IB6030M	IB6030A	IB6030B
	Smooth-Fit External Bend	EB6030W	EB6030M	EB6030A	EB6030B
	Smooth-Fit Flat Bend	FB6030W	FB6030M	FB6030A	FB6030B
	Smooth-Fit Equal Tee	ET6030W	ET6030M	ET6030A	ET6030B
	Smooth-Fit Cable Outlet	CO6030W	CO6030M	CO6030A	CO6030B
	Smooth-Fit Coupler	CP6030W	CP6030M	CP6030A	CP6030B
	Smooth-Fit End Cap	EC6030W	EC6030M	EC6030A	EC6030B
	15mm Twin Pipe Clip	15PR63W	-	-	-



1/4-Round 22 x 22mm Trunking/Floor Trim

		White	Oak Effect	Stainable	Light Oak Effect
Lengths	3.0m Length	R3D22QSW	-	-	-
	2.0m Length	R2D22QSW	R2D22QSO	R2D22QSP	RD22QSF1
Clip-Over Accessories	Clip-Over Internal / Flat Bend	FLIB22QSW	FLIB22QSO	FLIB22QSP	FLIB22QSF1
	Clip-Over External Bend	FLEB22QSW	FLEB22QSO	FLEB22QSP	FLEB22QSF1
	Clip-Over Inlet/Outlet	FLC022QSW	FLC022QSO	FLC022QSP	FLC022QSF1
Smooth-Fit Accessories	Smooth-Fit Internal/Flat Bend	FB22QSW	FB22QSO	FB22QSP	-
	Smooth-Fit External Bend	EB22QSW	EB22QSO	EB22QSP	-
	Smooth-Fit Cable Inlet	CI22QSW	CI22QSO	CI22QSP	-
	Smooth-Fit Cable Outlet	CO22QSW	CO22QSO	CO22QSP	-
	Smooth-Fit Coupler	CP22QSW	CP22QSO	CP22QSP	-
	Smooth-Fit End Cap (left)	EC22QSW/L	EC22QSO/L	EC22QSP/L	EC22QSF1/L
	Smooth-Fit End Cap (right)	EC22QSW/R	EC22QSO/R	EC22QSP/R	EC22QSF1/R



1/4-Round 30 x 30mm Trunking

		White	Magnolia	Oak Effect
Lengths	3.0m Length	R3D30QSW	-	-
	2.0m Length	R2D30QSW	R2D30QSM	R2D30QSO
Smooth-Fit Accessories	Smooth-Fit Internal / Flat Bend	FB30QSW	FB30QSM	FB30QSO
	Smooth-Fit External Bend	EB30QSW	EB30QSM	EB30QSO
	Smooth-Fit Cable Outlet	CO30QSW	CO30QSM	CO30QSO
	Smooth-Fit Corner Tee	CT30QSW	-	-
	Smooth-Fit Coupler	CP30QSW	CP30QSM	CP30QSO
	Smooth-Fit Box Adaptor	AT30QSW	-	AT30QSO
	Smooth-Fit Reducing Tee (to 30x15)	RT30QSW	RT30QSM	RT30QSO
	Smooth-Fit End Cap (left)	EC30QSW/L	EC30QSM/L	EC30QSO/L
	Smooth-Fit End Cap (right)	EC30QSW/R	EC30QSM/R	EC30QSO/R

Colours





W White
 M Magnolia
 A Aluminium Effect
 B Black
 O Oak Effect
 R Red
 P Premium Wood (stainable 22x22 only)*
 F1 Light Oak Effect

illustrations not to scale

Shape & size (wxh)

Trunking Lengths

3m Length
 2m Length
 3m Self Adhesive Divider
 suitable for all colours

								
	60x30mm	50x25mm	40x20mm	30x15mm	20x10mm	16x8mm	22x22mm	30x30mm
3m Length	<input type="checkbox"/>	<input type="checkbox"/>	<input type="checkbox"/>	<input type="checkbox"/>	<input type="checkbox"/>	<input type="checkbox"/>	<input type="checkbox"/>	<input type="checkbox"/>
2m Length	<input type="checkbox"/>	<input type="checkbox"/>	<input type="checkbox"/>	<input type="checkbox"/>	<input type="checkbox"/>	<input type="checkbox"/>	<input type="checkbox"/>	<input type="checkbox"/>
3m Self Adhesive Divider	<input type="checkbox"/>	<input type="checkbox"/>	<input type="checkbox"/>	<input type="checkbox"/>	<input type="checkbox"/>	<input type="checkbox"/>	<input type="checkbox"/>	<input type="checkbox"/>

Clip-Over Accessories

Flat Bend	<input type="checkbox"/>	<input type="checkbox"/>	<input type="checkbox"/>	<input type="checkbox"/>	<input type="checkbox"/>	<input type="checkbox"/>	<input type="checkbox"/>	<input type="checkbox"/>	use internal bend
Internal Bend	<input type="checkbox"/>	<input type="checkbox"/>	<input type="checkbox"/>	<input type="checkbox"/>	<input type="checkbox"/>	<input type="checkbox"/>	<input type="checkbox"/>	<input type="checkbox"/>	<input type="checkbox"/>
External Bend	<input type="checkbox"/>	<input type="checkbox"/>	<input type="checkbox"/>	<input type="checkbox"/>	<input type="checkbox"/>	<input type="checkbox"/>	<input type="checkbox"/>	<input type="checkbox"/>	<input type="checkbox"/>
Equal Tee	<input type="checkbox"/>	<input type="checkbox"/>	<input type="checkbox"/>	<input type="checkbox"/>	<input type="checkbox"/>	<input type="checkbox"/>	<input type="checkbox"/>	<input type="checkbox"/>	<input type="checkbox"/>
Door Top Bend	use flat bend		<input type="checkbox"/>	<input type="checkbox"/>	use flat bend		<input type="checkbox"/>	<input type="checkbox"/>	<input type="checkbox"/>
Box Adaptor Tee (50x25 only)	<input type="checkbox"/>	<input type="checkbox"/>	<input type="checkbox"/>	<input type="checkbox"/>	<input type="checkbox"/>	<input type="checkbox"/>	<input type="checkbox"/>	<input type="checkbox"/>	<input type="checkbox"/>
Inlet/Outlet Coupler (22x22 only)	<input type="checkbox"/>	<input type="checkbox"/>	<input type="checkbox"/>	<input type="checkbox"/>	<input type="checkbox"/>	<input type="checkbox"/>	<input type="checkbox"/>	<input type="checkbox"/>	<input type="checkbox"/>
Flat Adaptor	<input type="checkbox"/>	<input type="checkbox"/>	<input type="checkbox"/>	<input type="checkbox"/>	<input type="checkbox"/>	<input type="checkbox"/>	<input type="checkbox"/>	<input type="checkbox"/>	<input type="checkbox"/>

Smooth Fit Accessories

Flat Bend	<input type="checkbox"/>	<input type="checkbox"/>	<input type="checkbox"/>	<input type="checkbox"/>	<input type="checkbox"/>	<input type="checkbox"/>	<input type="checkbox"/>	<input type="checkbox"/>	<input type="checkbox"/>
Internal Bend	<input type="checkbox"/>	<input type="checkbox"/>	<input type="checkbox"/>	<input type="checkbox"/>	<input type="checkbox"/>	<input type="checkbox"/>	<input type="checkbox"/>	<input type="checkbox"/>	use flat bend
External Bend	<input type="checkbox"/>	<input type="checkbox"/>	<input type="checkbox"/>	<input type="checkbox"/>	<input type="checkbox"/>	<input type="checkbox"/>	<input type="checkbox"/>	<input type="checkbox"/>	<input type="checkbox"/>
Equal Tee	<input type="checkbox"/>	<input type="checkbox"/>	<input type="checkbox"/>	<input type="checkbox"/>	<input type="checkbox"/>	<input type="checkbox"/>	<input type="checkbox"/>	<input type="checkbox"/>	<input type="checkbox"/>
Cable Outlet	<input type="checkbox"/>	<input type="checkbox"/>	<input type="checkbox"/>	<input type="checkbox"/>	<input type="checkbox"/>	<input type="checkbox"/>	<input type="checkbox"/>	<input type="checkbox"/>	<input type="checkbox"/>
Cable Inlet	<input type="checkbox"/>	<input type="checkbox"/>	<input type="checkbox"/>	<input type="checkbox"/>	<input type="checkbox"/>	<input type="checkbox"/>	<input type="checkbox"/>	<input type="checkbox"/>	<input type="checkbox"/>
Reducing Tee (to 30x15mm)	<input type="checkbox"/>	<input type="checkbox"/>	<input type="checkbox"/>	<input type="checkbox"/>	<input type="checkbox"/>	<input type="checkbox"/>	<input type="checkbox"/>	<input type="checkbox"/>	<input type="checkbox"/>
Coupler	<input type="checkbox"/>	<input type="checkbox"/>	<input type="checkbox"/>	<input type="checkbox"/>	<input type="checkbox"/>	<input type="checkbox"/>	<input type="checkbox"/>	<input type="checkbox"/>	<input type="checkbox"/>
End Cap	<input type="checkbox"/>	<input type="checkbox"/>	<input type="checkbox"/>	<input type="checkbox"/>	<input type="checkbox"/>	<input type="checkbox"/>	<input type="checkbox"/>	<input type="checkbox"/>	<input type="checkbox"/>
End Cap Left (¼ round only)	<input type="checkbox"/>	<input type="checkbox"/>	<input type="checkbox"/>	<input type="checkbox"/>	<input type="checkbox"/>	<input type="checkbox"/>	<input type="checkbox"/>	<input type="checkbox"/>	<input type="checkbox"/>
End Cap Right (¼ round only)	<input type="checkbox"/>	<input type="checkbox"/>	<input type="checkbox"/>	<input type="checkbox"/>	<input type="checkbox"/>	<input type="checkbox"/>	<input type="checkbox"/>	<input type="checkbox"/>	<input type="checkbox"/>
10mm Pipe Exit End Cap	<input type="checkbox"/>	<input type="checkbox"/>	<input type="checkbox"/>	<input type="checkbox"/>	<input type="checkbox"/>	<input type="checkbox"/>	<input type="checkbox"/>	<input type="checkbox"/>	<input type="checkbox"/>
Corner Tee	<input type="checkbox"/>	<input type="checkbox"/>	<input type="checkbox"/>	<input type="checkbox"/>	<input type="checkbox"/>	<input type="checkbox"/>	<input type="checkbox"/>	<input type="checkbox"/>	<input type="checkbox"/>
Box Adaptor Tee	<input type="checkbox"/>	<input type="checkbox"/>	<input type="checkbox"/>	<input type="checkbox"/>	<input type="checkbox"/>	<input type="checkbox"/>	<input type="checkbox"/>	<input type="checkbox"/>	<input type="checkbox"/>
30x15mm Box Adaptor	<input type="checkbox"/>	<input type="checkbox"/>	<input type="checkbox"/>	<input type="checkbox"/>	<input type="checkbox"/>	<input type="checkbox"/>	<input type="checkbox"/>	<input type="checkbox"/>	<input type="checkbox"/>
Patress Adaptor	<input type="checkbox"/>	<input type="checkbox"/>	<input type="checkbox"/>	<input type="checkbox"/>	<input type="checkbox"/>	<input type="checkbox"/>	<input type="checkbox"/>	<input type="checkbox"/>	<input type="checkbox"/>
Circular Adaptor	<input type="checkbox"/>	<input type="checkbox"/>	<input type="checkbox"/>	<input type="checkbox"/>	<input type="checkbox"/>	<input type="checkbox"/>	<input type="checkbox"/>	<input type="checkbox"/>	<input type="checkbox"/>

Safe-D Clips - Fire Rated

SAFE-D30 (BS5839 part 1)	<input type="checkbox"/>	<input type="checkbox"/>	<input type="checkbox"/>	<input checked="" type="checkbox"/>	<input type="checkbox"/>	<input type="checkbox"/>	<input type="checkbox"/>	<input type="checkbox"/>	<input checked="" type="checkbox"/>
SAFE-D40 (BS5839 part 1)	<input type="checkbox"/>	<input checked="" type="checkbox"/>	<input checked="" type="checkbox"/>	<input checked="" type="checkbox"/>	<input type="checkbox"/>	<input type="checkbox"/>	<input type="checkbox"/>	<input type="checkbox"/>	<input type="checkbox"/>
SAFE-D50 (BS5839 part 1)	<input checked="" type="checkbox"/>	<input type="checkbox"/>	<input type="checkbox"/>	<input type="checkbox"/>	<input type="checkbox"/>	<input type="checkbox"/>	<input type="checkbox"/>	<input type="checkbox"/>	<input type="checkbox"/>

Surface Boxes

28mm Deep Single	<input type="checkbox"/>
28mm Deep Twin	<input type="checkbox"/>
35mm Deep Single	<input type="checkbox"/>
35mm Deep Twin	<input type="checkbox"/>
28mm Rounded Single	<input type="checkbox"/>
28mm Rounded Twin	<input type="checkbox"/>
35mm Rounded Single	<input type="checkbox"/>
35mm Rounded Twin	<input type="checkbox"/>

Clip-Over Accessories



Smooth Fit Accessories



* All oak/wood trunking accessories are brown finish, but can be stained to achieve best colour co-ordination to stained lengths (key surface of accessory with fine abrasive prior to staining)

1/2-Round Clip-Over Accessories - For 20x10mm, 30x15mm and 50x25mm only



Internal Bend
Join lengths around 90 degree inside corners.



External Bend
Join lengths around 90 degree outside corners.

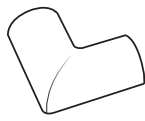

Flat Bend
Change direction by 90 degrees on flat surfaces.

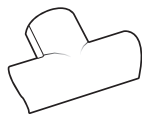

Equal Tee
Use to join 3 lengths of same profile.

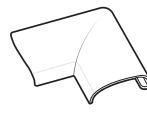

Door Top Bend
Change direction by 90 degrees around frame tops.

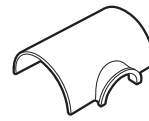

Box Adaptor Tee
For use with D-Line Surface Socket Boxes. **50 x 25mm only**

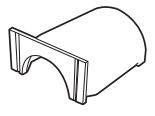

Flat Adaptor
Connect Mini Trunking to flat surfaces **30 x 15mm only**

1/4-Round Clip-Over Accessories - For 22x22mm only



Internal Bend
Join lengths around 90 degree inside corners.



External Bend
Join lengths around 90 degree outside corners.



Cable Inlet/Outlet
Use to provide cable entry/exit point between 2 lengths.



Use with Smooth-Fit Couplers & End Caps

1/2-Round Smooth-Fit Accessories

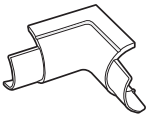

Internal Bend
Join lengths around 90 degree inside corners.

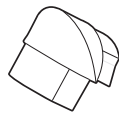

External Bend
Join lengths around 90 degree outside corners.

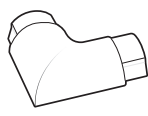

Flat Bend
Change direction by 90 degrees on flat surfaces.

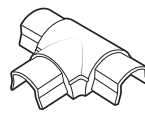

Equal Tee
Use to join 3 lengths of same profile.

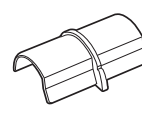

Coupler
Join 2 lengths of same profile on flat surface.

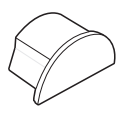

End Cap
Neatly finish open ends.

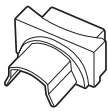

Pattress Adaptor
Connect Mini Trunking to round surface pattresses. **30 x 15mm only**

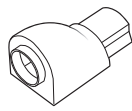

Circular Adaptor
Connect Mini Trunking to flat edge surfaces with 20mm Ø knock-outs. **30 x 15mm only**

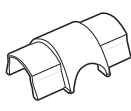

Cable Inlet/Outlet
Takes cables in or out of a Mini Trunking. Use between lengths on straight runs. **30 x 15mm only**

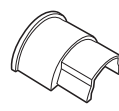

Box Adaptor
For use with D-Line Surface Socket Boxes. **30 x 15mm only**

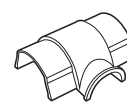

Box Adaptor Tee
For use with D-Line Surface Socket Boxes.

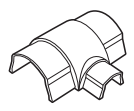

Reducing Tee
Connect to 30 x 15mm Mini Trunking.

1/4-Round Smooth-Fit Accessories



Internal Bend
Join lengths around 90 degree inside corners.

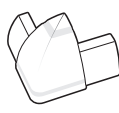

External Bend
Join lengths around 90 degree outside corners.

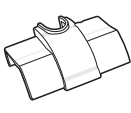

Cable Inlet
Use to provide cable entry point between 2 lengths.

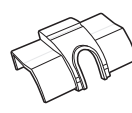

Cable Outlet
Use to provide cable exit point between 2 lengths.

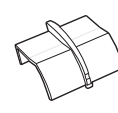

Coupler
Joins 2 lengths on flat surfaces.

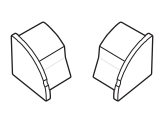

End Cap
Neatly finish open ends (left & right versions apply).

Other Accessories

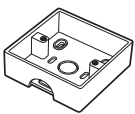

Single Surface Socket Box
For use with 30 x 15mm, 40 x 20mm & 50 x 25mm Trunking. Available in 28mm & 35mm depth.

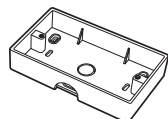

Twin Surface Socket Box
For use with 30 x 15mm, 40 x 20mm & 50 x 25mm Trunking. Available in 28mm & 35mm depth.



SAFE-D30 Clip
Fire rated cable clip for use with 30 x 15mm D-Line & 25mm+ wide traditional trunkings. Safe-D Red version also available.

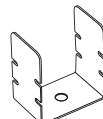

SAFE-D40 Clip
Fire rated cable clip for use with 40 x 20mm & 50 x 25mm D-Line & 40mm+ wide traditional trunkings.

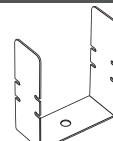

SAFE-D50 Clip
Fire rated cable clip for use with 60 x 30mm D-Line & 50mm+ wide traditional trunkings.



Ratchet Cutting Tool
Use to cut up to 40mm wide D-Line Trunking.



About D-Line Safe-D® Clips

Fully tested & certified... Clip & Comply

It is widely accepted that plastic cable clips or plastic containment systems should never be the sole means of cable support. PVC will typically disintegrate at approximately 160°C, causing cables to drop in fires which will often reach temperatures in range 600-900°C.

In fires, fallen cables can cause horrific fatalities, making 'impenetrable webs' that can be death traps.

D-Line Safe-D Clips were the first fire-rated clips that could be installed in non-metallic trunkings. Produced from non-alloy high temperature steel, D-Line Safe-D Clips

are fully tested and certified as capable of supporting cables in temperatures of 970°C for 2 hours, allowing time to evacuate densely populated buildings.

Use with fire-rated fixings such as DeWalt WallDOGS or cartridge nails, which eliminate need for plastic anchors.





After firstly securing the Safe-D Clips in trunking, or direct to surface (ideally at 300mm intervals for horizontal installation, or 400mm vertically) installers simply fold over thumb-friendly tabs to hold the cables.

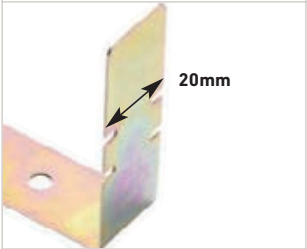
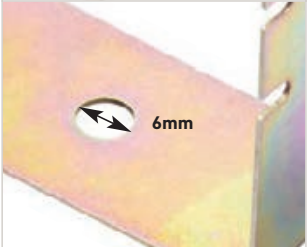

After 2 hour burn test

Safe-D Clips Test & Certification - Conclusion (extract)...

"The test results demonstrate that the cable retaining clips do not reduce the circuit integrity below that afforded by the standard fire resisting cable used, and that they withstand a similar temperature and duration to that of a standard fire resisting cable, while maintaining adequate support. Consequently, the test results demonstrate that the clips meet the requirements of section 26.2 e) of BS 5839-1."

	FEATURE	BENEFIT
	Alternative options	<ul style="list-style-type: none"> • Alternative solutions for trunking up to 50mm width - or fix direct to surface
	20mm wide side-tabs	<ul style="list-style-type: none"> • Thumb friendly, pliable gauge, easy to fold - quick to install • Non-corrosive coating on all faces & edges • Cables can be added or removed
	6mm fixing hole	<ul style="list-style-type: none"> • Can accept all popular fire rated fixings
	Round corners	<ul style="list-style-type: none"> • Protects cable sheaths (and hands!) • User friendly • Satisfying design code BS7671 s522.8.11
	Tested & Certified	<ul style="list-style-type: none"> • Peace of mind • Assured performance • Produced from traceable steel (no alloys)
	<p>Fix for example by Multi-Purpose DEWALT WallDog™ - or cartridge nails</p>	<ul style="list-style-type: none"> • No wall plugs required • Use to fasten Safe-D Clips in trunking or directly to drywall, wood, concrete, sandstone limestone or brickwork





Safe-D 30 Fire Rated Clips For 25mm+ Trunkings

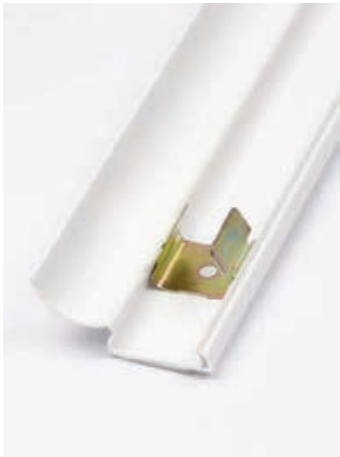

Suitable for direct to surface fitting

Safe-D30 Clips fit perfectly in 30 x 15mm Mini Trunking while the 23mm base can fit 25 x 16mm traditional trunking also.

Alternatively Safe-D30's can be fixed directly to surfaces, with user-friendly and pliable tabs that simply fold-over to secure cables. **1st fix clips, then 2nd fix cables!**

- Certified for 2 hours at 970°C
- Fully safety tested and certified to BS5839 part 1 compliant
- Thumb friendly, easy fold side-tabs
- Passivated non-corrosive coating
- Ideal for ceiling voids, or popular PVC trunking
- Rounded edges for easy handling

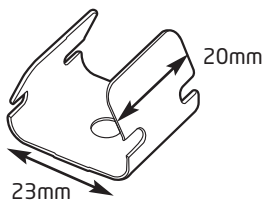

Code	Description
SAFE-D30/100	(L) 20mm x (W) 23mm x (H) 8mm (folded) 6mm diameter pre-drilled hole in base

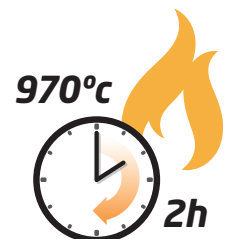



Safe-D 30 Red Fire Rated Clips

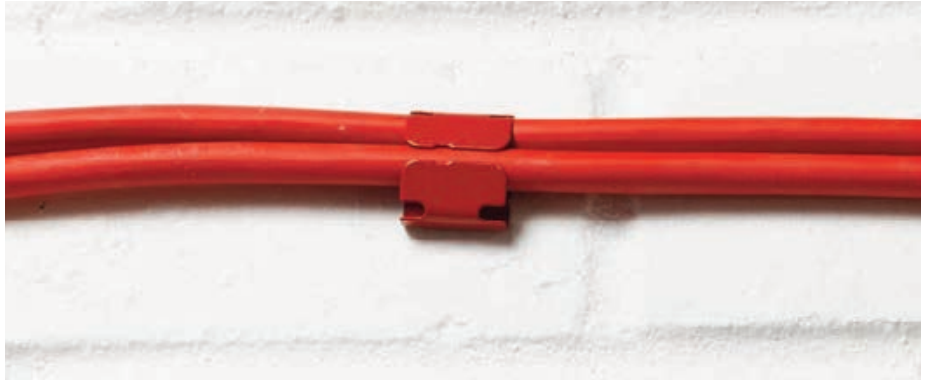

Suitable for direct to surface fitting

Safe-D30 Red Fire Rated Clips can be fitted directly to surfaces, with tabs that simply fold-over to secure cables.

The red finish makes a popular solution for containing red-sheathed fire performance cables direct to surface. The 23mm width is ideal for popular 2x MICC or FP-cable combinations. **1st fix clips, then 2nd fix cables!**

- Certified for 2 hours at 970°C
- Fully safety tested and certified to BS5839 part 1 compliant
- Thumb friendly, easy fold side-tabs
- Passivated non-corrosive coating
- Ideal for fixing direct to surface
- Rounded edges for easy handling

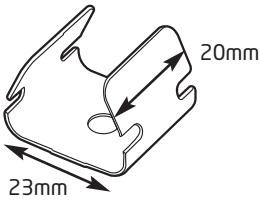

Code	Description
SAFE-D30/RED	(L) 20mm x (W) 23mm x (H) 8mm (folded) 6mm diameter pre-drilled hole in base

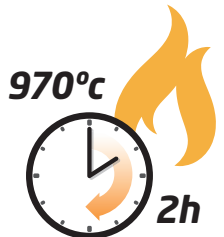

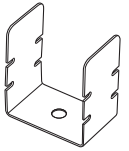

Safe-D 40 Fire Rated Clips For 38mm+ Trunkings

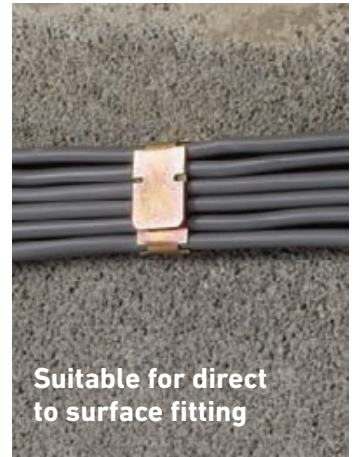
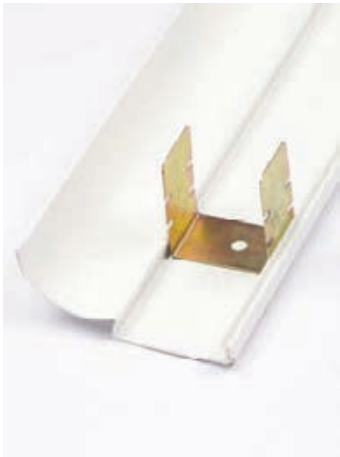

Suitable for direct to surface fitting

Safe-D40 Clips are popular for fitment in 38mm or 40mm non-metallic trunking bases, or to provide a first-fix solution for securing cables direct to surfaces.

Installers should use a fire-rated fixing, and then simply fold-over tabs to secure cables. **1st fix clips, then 2nd fix cables!**

- Certified for 2 hours at 970°C
- Fully safety tested and certified to BS5839 part 1 compliant
- Thumb friendly, easy fold side-tabs
- Passivated non-corrosive coating
- Ideal for ceiling voids, or popular PVC trunking
- Rounded edges for easy handling

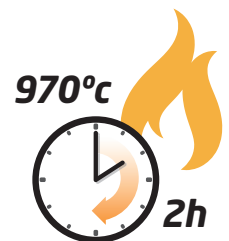
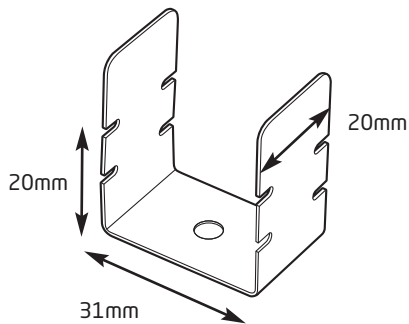

Code	Description
SAFE-D40/50	(L) 20mm x (W) 31mm x (H) 20mm (folded - max height) 6mm diameter pre-drilled hole in base

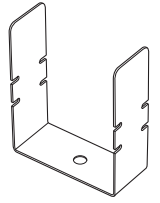

Safe-D 50 Fire Rated Clips For 50mm+ Trunkings

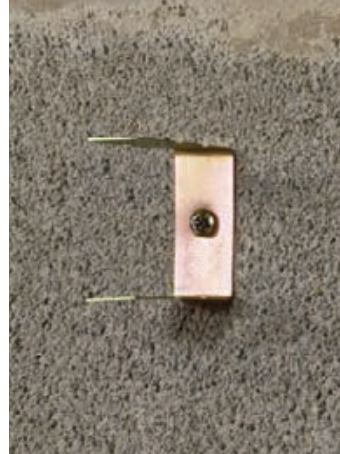
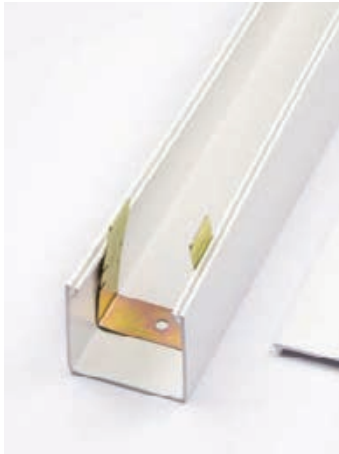

Suitable for direct to surface fitting

Safe-D50 Clips are popular for fitment in 50mm non-metallic trunking bases, or to provide a first-fix solution for securing cables direct to surfaces.

Installers should use a fire-rated fixing, then simply fold over tabs to secure cables. **1st fix clips, then 2nd fix cables!**

- Certified for 2 hours at 970°C
- Fully safety tested and certified to BS5839 part 1 compliant
- Thumb friendly, easy fold side-tabs
- Passivated non-corrosive coating
- Ideal for ceiling voids, or popular PVC trunking
- Rounded edges for easy handling

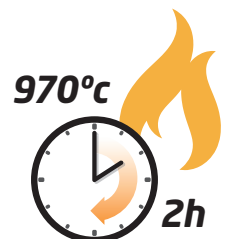
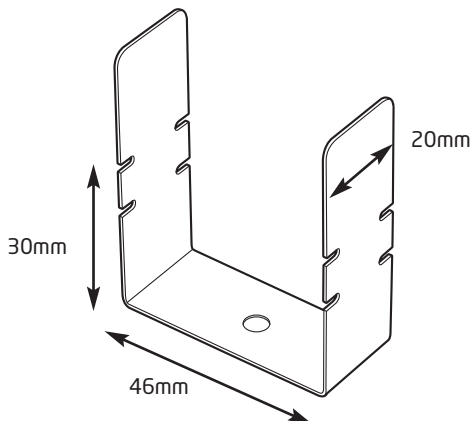

Code	Description
SAFE-D50/50	(L) 20mm x (W) 46mm x (H) 30mm (folded - max height) 6mm diameter pre-drilled hole in base

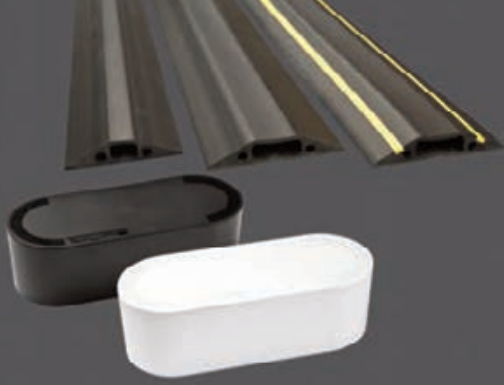

About D-Line Cable Safety Products

In recent years it is a fact that personal work spaces and living spaces have both reduced, while at the same time the volume of cables around us, and often under our feet, has increased. The impact of both trends make cable management a critical issue, which requires a pro-active and responsible approach.

When left unchecked, cables can make accidents waiting to happen. They create one of the most common causes of trips and falls, giving rise to often significant compensation awards from cable accidents which sometimes have devastating consequences.

Damaged cables and overloaded socket blocks can create electrical shocks and pose a serious fire risk.

Approximately 3,000 electrical fires occur annually in UK from cables, socket extensions and plugs.

Socket blocks and associated cable clutter can also be impossible to clean around, creating breeding grounds for allergens, an appearance of inefficiency, and a frequent cause of disconnections – and lost productivity, as feet become entangled in cables under desks.

Accidents, injuries and lost productivity from cable hazards are however almost entirely preventable – by using innovative cable safety products which can fit simply around trailing cables and socket blocks.

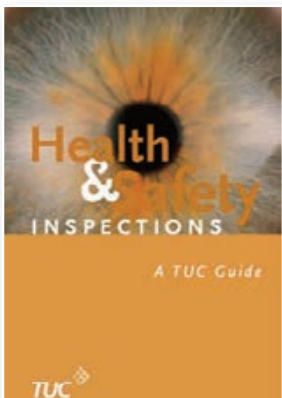
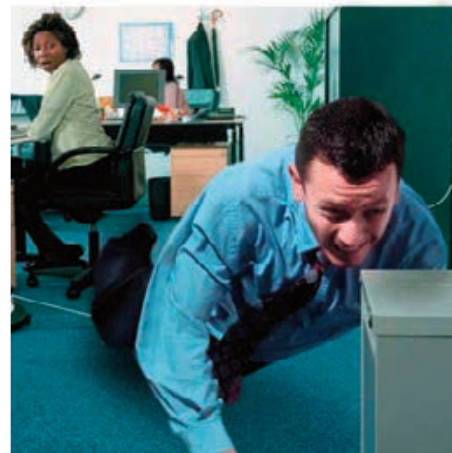
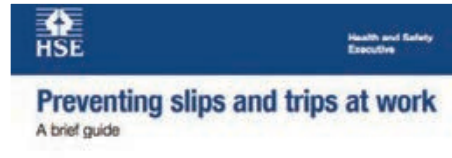
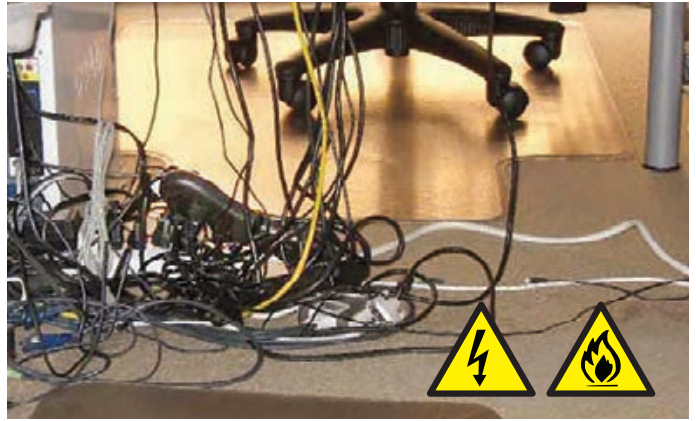

Light Duty Floor Cable Protector

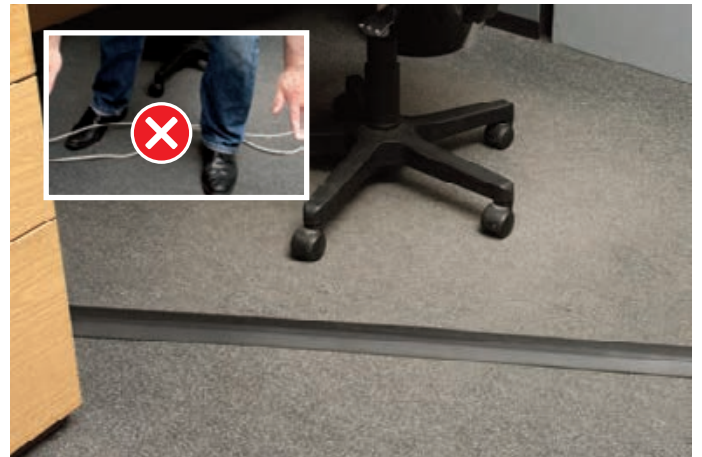
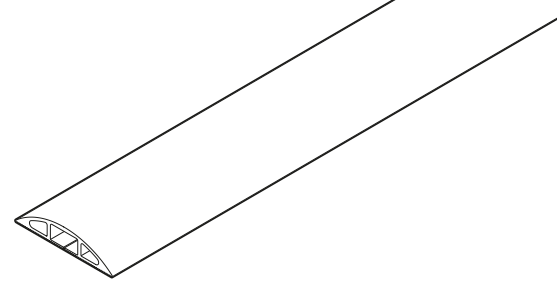

Light Duty Floor Cable Protectors are popular as a temporary solution to cover cables across open areas with light foot traffic.

The 17 x 9mm cavity can accommodate 2x 8mm outer diameter flex cables.

- Ideal for areas with light foot traffic
- Address a common cause of trips, tugs and falls
- Can protect up to 2x 8mm diameter cables
- Ribbed non-slip base, pre-split rear for ease of use
- Flexible PVC - Supplied coiled in box; simply uncoil to lay flat
- Fully safety tested and certified to BS EN 60670-1:2005

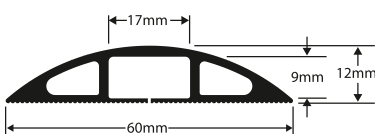

Code	Description
CC-1	(L) 1.8m x (W) 60mm x (H) 12mm Inner channel - (W) 17mm x (H) 9mm
CC-1/9M	(L) 9.0m x (W) 60mm x (H) 12mm Inner channel - (W) 17mm x (H) 9mm

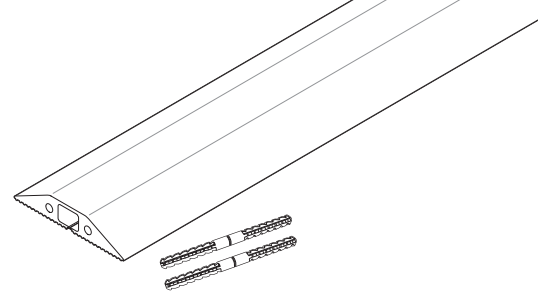

Medium Duty Floor Cable Protector

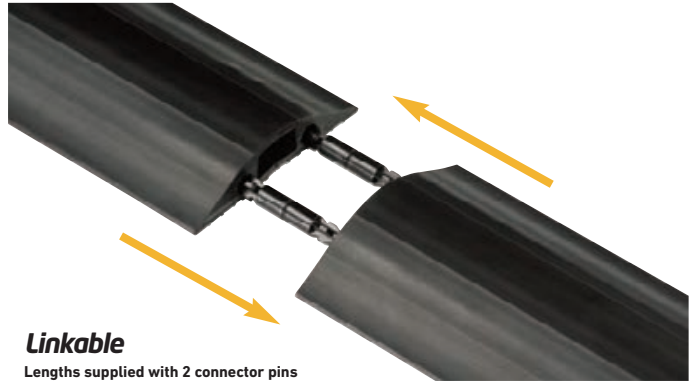

The heavier gauge design of Medium Duty Floor Cable Protectors addresses cable trip hazards... while providing effective protection for cables.

By minimising the risk of split insulation and damaged conductor strands, the danger of electrocution and hot spots (that create fire risks) is minimised also.

Lengths are available as 1.8m or 9m options, and supplied with friction-fit connector pins so that they can be joined to make continuous runs when necessary.

- Ideal for areas with regular foot traffic
- Protect cables, and address a common cause of trips and falls
- 14mm x 9mm cavity
- Ribbed non-slip base, pre-split rear for ease of use
- Flexible PVC - Neat tapered design, lengths uncoil to lay flat
- Fully safety tested and certified to BS EN 60670-1:2005

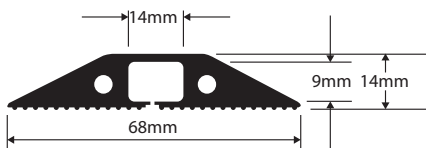

Code	Description
FC68B	(L) 1.8m x (W) 68mm x (H) 14mm Inner channel - (W) 14mm x (H) 9mm
FC68B/9M	(L) 9.0m x (W) 68mm x (H) 14mm Inner channel - (W) 14mm x (H) 9mm

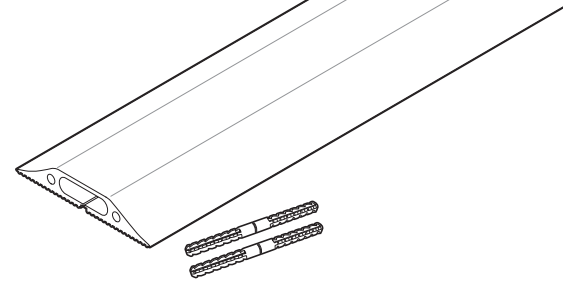

Medium Duty Floor Cable Protector

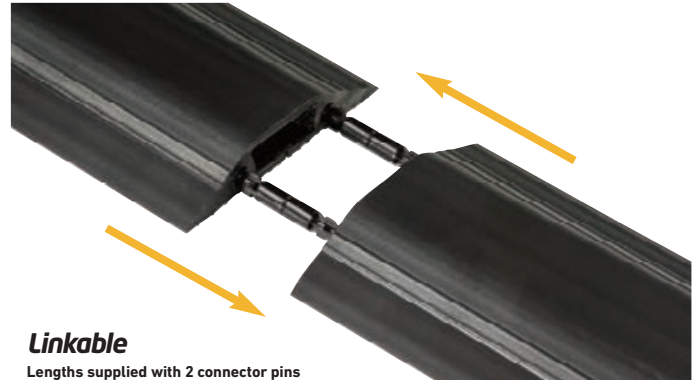

Medium Duty profiles uncoil to effectively lay flat across surfaces, while the tapered sloping sides are pedestrian-friendly. The pre-split back enables users to simply retrofit the profile over the cables. Features combine so that cables can be contained within the cavity, with minimal risk of movement.

The unique connector pins provide an effective friction-fit connection that can be pushed-in, then later pulled apart, in adjoining lengths – to cover whatever length of cable is required. It is insufficient covering, say, only two-thirds of a trailing cable!

- Ideal for areas with regular foot traffic
- Protect cables, and address a common cause of trips and falls
- 30mm x 10mm cavity
- Ribbed non-slip base, pre-split rear for ease of use
- Flexible PVC - Neat tapered design, lengths uncoil to lay flat
- Fully safety tested and certified to BS EN 60670-1:2005

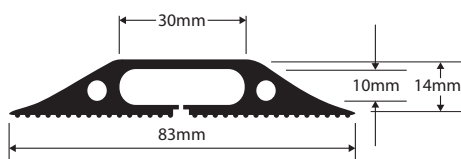

Code	Description
FC83B	(L) 1.8m x (W) 83mm x (H) 14mm Inner channel - (W) 30mm x (H) 10mm
FC83B/9M	(L) 9.0m x (W) 83mm x (H) 14mm Inner channel - (W) 30mm x (H) 10mm

Medium Duty Floor Cable Protector with Hazard Stripe

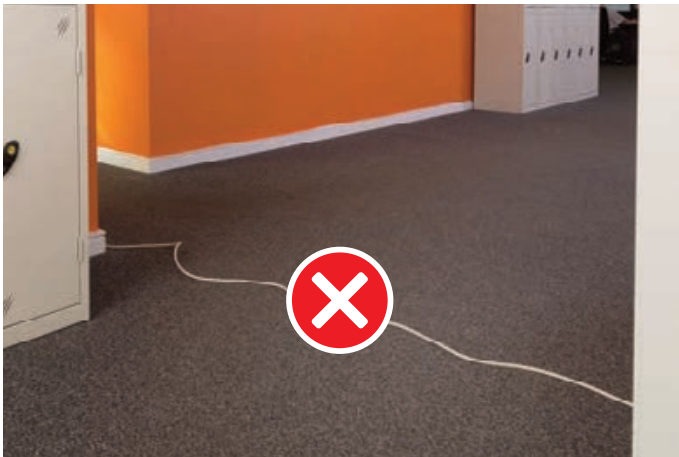
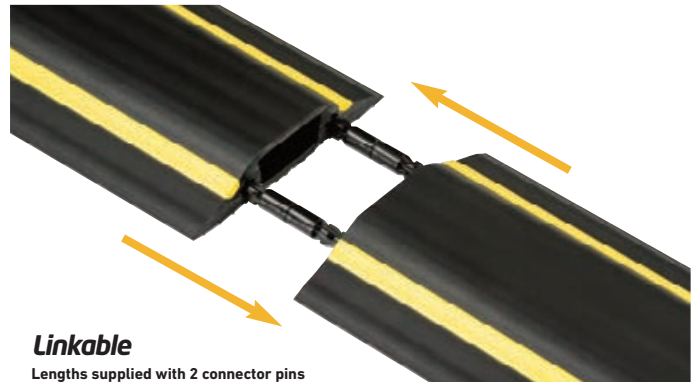
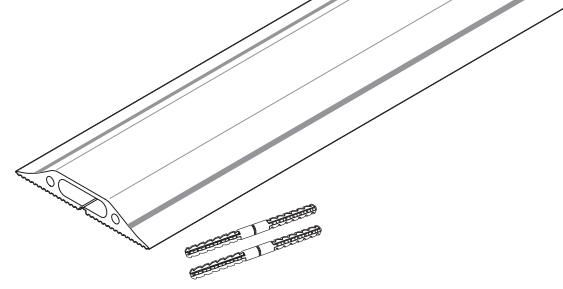

Ideal for up to 3x 8mm diameter cables, this versatile Cable Protector is supplied with connector pins so it can be cut to shorten, then reconnected or combined with other lengths to make longer runs.

The hazard stripe gives greater visibility to pedestrians.

Available in 1.8m lengths, or 9m length options.

Supplied with connector pins, so lengths can be joined to make longer runs.

- Ideal for areas with regular foot traffic
- Protect cables, and address a common cause of trips and falls
- Prevent cable insulation damage/electrocution and risk of broken conductor strands
- 30mm x 10mm cavity
- Ribbed non-slip base, pre-split rear for ease of use
- Flexible PVC - Neat tapered design, lengths uncoil to lay flat
- No sharp kerb-effect, pedestrian friendly
- Fully safety tested and certified to BS EN 60670-1:2005

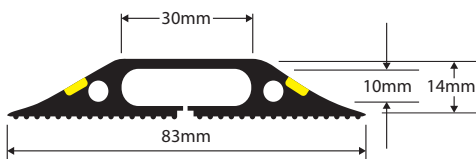

Code	Description
FC83H	(L) 1.8m x (H) 83mm x (H) 14mm Inner channel - (W) 30mm x (H) 10mm
FC83H/9M	(L) 9.0m x (H) 83mm x (H) 14mm Inner channel - (W) 30mm x (H) 10mm

Medium Duty Floor Cable Protector 2 Compartment

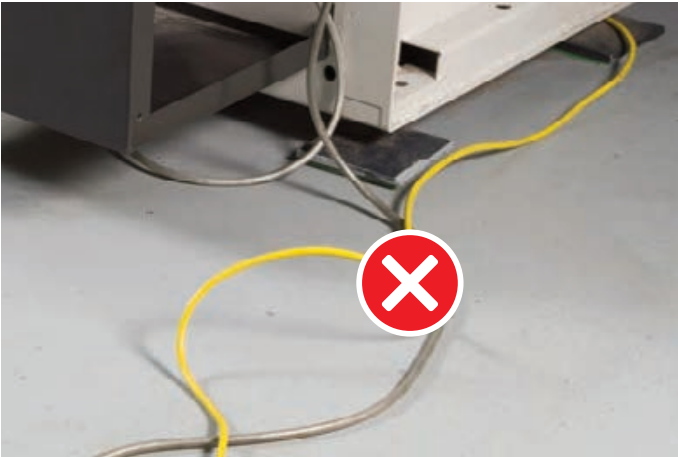
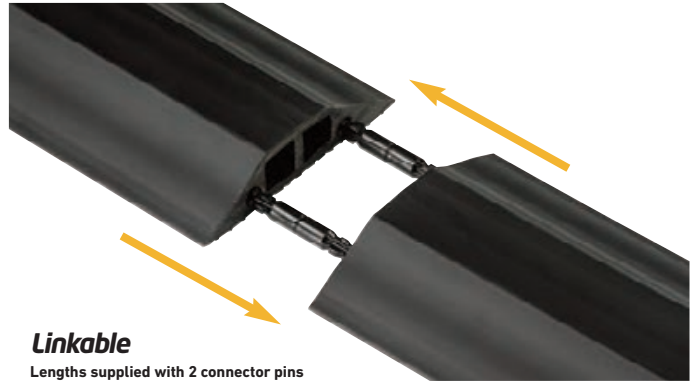
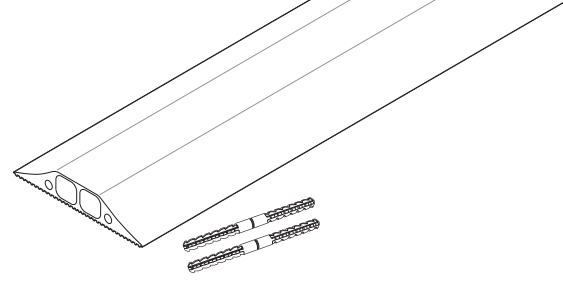

Medium Duty 2-compartment Floor Cable Protectors are ideal if segregation is required between cable types; for example to separate mains voltage and low-voltage cables.

Same as all D-Line Medium Duty Cable Protectors, the rear is ribbed to minimise movement on smooth surfaces.

Both cavities offer 12 x 13mm inner capacity.

Supplied with connector pins, so lengths can be joined to make longer runs.

- Ideal for areas with regular foot traffic
- Protect cables, and address a common cause of trips and falls
- Prevent cable insulation damage/electrocution and risk of broken conductor strands
- 2 x 13mm x 12mm cavity
- Ribbed non-slip base
- Flexible PVC - Neat tapered design, lengths uncoil to lay flat
- No sharp kerb-effect, pedestrian friendly
- Fully safety tested and certified to BS EN 60670-1:2005

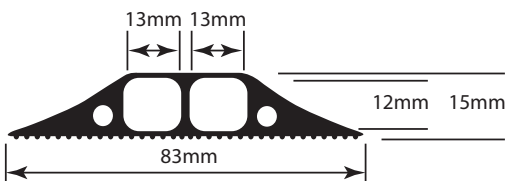

Code	Description
FC83B/2C/9M	(L) 9.0m x (W) 83mm x (H) 15mm 2x Inner channels - (W) 13mm x (H) 12mm

Cable Grip Strip

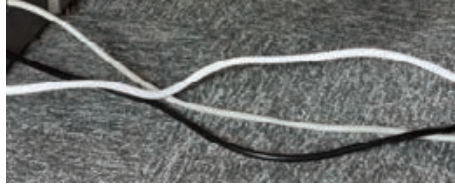
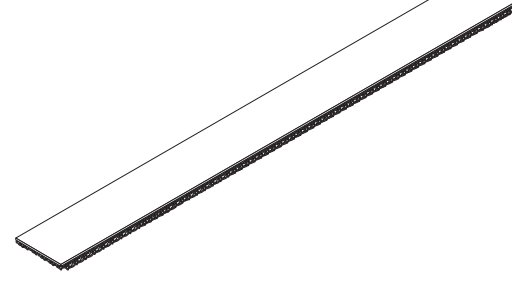

Cable Grip Strip is a neat and easy way to keep cables in place, and to eliminate risk of cables becoming a hazard.

Installers simply attach the Cable Grip Strip over cables. The 75mm wide x 3m long strip has hooks on rear which grip to closed-loop commercial carpet designs.

Ideal on floors under desks, or around floor perimeters, Cable Grip Strip is easy to cut and can be removed and reused as required – with no adhesive residue!

- For under desks, and perimeter of carpeted office floors
- Hook design on rear grips to commercial office carpets/carpet tiles
- Easy to remove, reusable, no adhesive residue
- Flat design, supplied coiled
- Simply scissor cut to size then pinch cables and lay over cable length(s)
- Not designed to protect cables from pedestrian traffic, but ideal to keep cables in position

Code	Description
CGS3B	(L) 3m x (W) 75mm

Caution: Cable Grip Strip should not be used on open-loop domestic type carpets, where fibres can be pulled-out on removal of the Grip Strip.

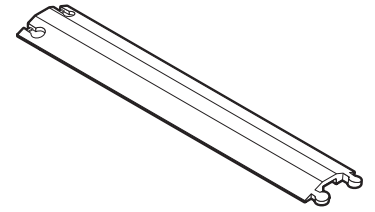

Rigid Single Channel Cable Protector



The smallest D-Line rigid Cable Protector lengths each have a simple and effective locking mechanism, so runs can be made in any length required.

The extremely durable polyurethane profiles simply drop over cables up to 12mm outer diameter. Use end caps for perfect finish.

The anti-slip treads and tapered sides are pedestrian friendly, while the strength of these profiles can accept the heaviest vehicular loads permissible on UK roads.

- Made from high-grade polyurethane, extremely robust
- Join by interlocking male:female connectors
- Tapered design & non-slip treads for pedestrian traffic
- Can accept up to 11.5t Axle Weight i.e. all vehicular traffic
- Durability gives exceptional value
- Fully safety tested and certified to BS7671:2008



Inner Channel: 38mm (W) x 12mm (H)

Code	Description
DO-1B765	(L) 765mm x (W) 133mm x (H) 22mm Inner channel - (W) 38mm x (H) 12mm
EC-1B765	End Cap Pair for DO-1B765

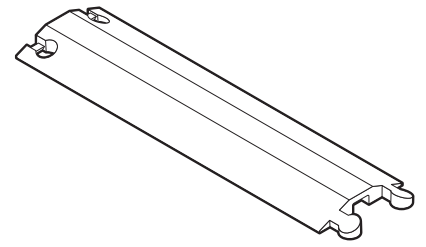

Rigid Single Channel Cable Protector



The larger D-Line drop over rigid Cable Protectors can accommodate cables or hoses up to 20mm diameter. Each length has a simple and effective locking mechanism, so runs can be made in any length required.

Anti-slip treads and tapered sides are pedestrian friendly, while the strength of these profiles can accept the heaviest vehicular loads permissible on UK roads.

- Made from high-grade polyurethane, extremely robust
- Join by interlocking male:female connectors
- Tapered design & non-slip treads for pedestrian traffic
- Can accept up to 11.5t Axle Weight i.e. all vehicular traffic
- Durability gives exceptional value
- Fully safety tested and certified to BS7671:2008



Inner Channel: 45 mm (W) x 20mm (H)

Code	Description
DO-2B765	(L) 765mm x (W) 220mm x (H) 32mm Inner channel - (W) 45 mm x (H) 20mm

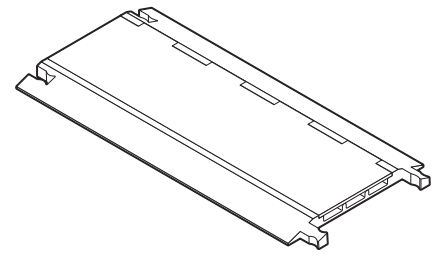

Heavy Duty Cable Protector - 3 Channel



This low-profile Cable Protector offers 3x channels that can each accept several cables (and hoses) up to 18mm diameter.

The lid makes it easy to add or remove cables.

High grade polyurethane provides exceptional strength versus all stress types to minimise risk of hinges cracking and detaching – so providing exceptional longevity and added-value in comparison to alternatives where lids and hinges can be prone to break on stress.

- Made from high-grade polyurethane, extremely robust
- Join by interlocking male:female connectors
- Tapered design & non-slip treads for pedestrian traffic
- Can accept up to 12.4t Axle Weight i.e. all vehicular traffic
- Durability gives exceptional value
- Carrying handle on reverse side
- Fully safety tested and certified to BS7671:2008



Cavity size: 3x 64mm (W) x 18mm (H)

Code	Description
DO-3BR920	(L) 920mm x (W) 460mm x (H) 35mm Inner channels - 3x (W) 64mm x (H) 18mm
EC-3BR920	End Cap Pair for DO-3BR920

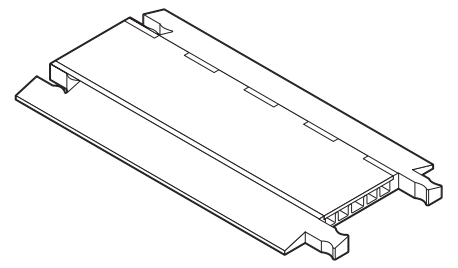

Heavy Duty Cable Protector - 5 Channel

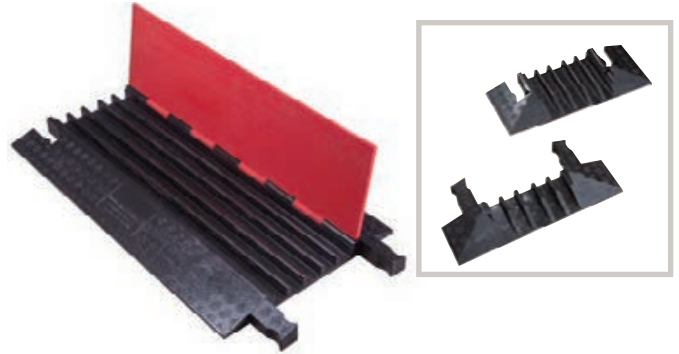
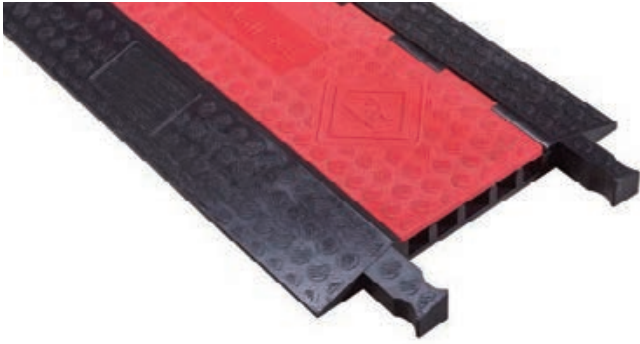

This 5x channel Cable Protector can accommodate cables and hoses up to 30mm diameter.

Note – the maximum axle weight allowable on UK roads is 11.5t, while this profile can withstand up to 15.4t so can accept all vehicular traffic.

These Cable Protectors are ideal for use in outdoor events, busy delivery depots, holiday parks and stadiums. They can accept all vehicular traffic.

- Made from high-grade polyurethane, extremely robust
- Join by interlocking male:female connectors
- Tapered design & non-slip treads for pedestrian traffic
- Can accept up to 15.4t Axle Weight i.e. all vehicular traffic
- Durability gives exceptional value
- Carrying handle on reverse side
- Fully safety tested and certified to BS7671:2008

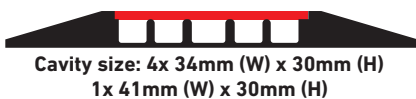

Code	Description
DX-5RB910	(L) 910mm x (W) 505mm x (H) 45mm Inner channels - 4x (W) 34mm x (H) 30mm & 1x (W) 41mm x (H) 30mm
EC-5RB910	End Cap Pair for EC-5RB910

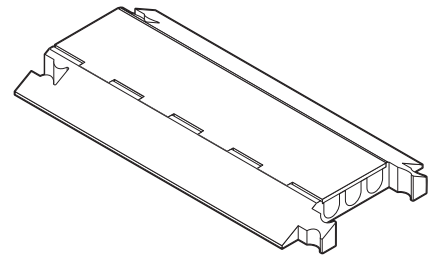

Heavy Duty Cable Protector - 3 Channel

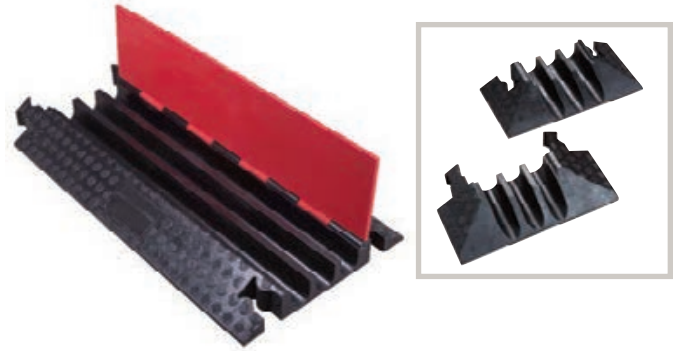

Heavy Duty Cable Protectors are often used in outdoor events, ports and busy depots, for roadworks, warehousing and stadiums.

These profiles offer 3x channels that accept cables and hoses up to 52mm outer diameter.

Extremely robust, all D-Line Heavy Duty Cable Protectors feature a carrying handle on rear. The hinged-lid enables cables to be inserted after the run is set-down.

Lengths can be joined to make runs as long as required.

Use end caps for perfect finish.

- Made from high-grade polyurethane, extremely robust
- Join by interlocking male:female connectors
- Tapered design & non-slip treads for pedestrian traffic
- Can accept up to 17.6t Axle Weight i.e. all vehicular traffic
- Durability gives exceptional value
- Carrying handle on reverse side
- Fully safety tested and certified to BS7671:2008



Cavity size: 3x 53x52mm

Code	Description
DX-3RB910	(L) 910mm x (W) 473mm x (H) 75mm Inner channel - 3x (W) 53mm x (H) 52mm
EC-3RB910	End Cap Pair for DX-3RB910

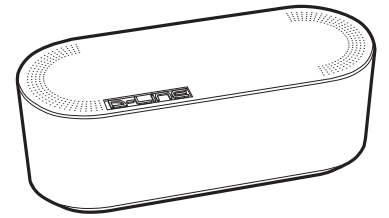

Socket Enclosures *Large*



D-Line Socket Enclosures (aka Cable Tidy Units) provide the most popular solution to contain extension sockets and cable spaghetti. The smart tech design blends with modern surroundings. 3x rear cable entry/exit slots enable cables to be routed to left-side, right-side or vertical.

Fully safety tested, and produced from electrically-safe robust ABS material with an effective click-lock lid, these Socket Enclosures sort unsightly cables and contribute to a positive Health & Safety culture.

Use large unit to contain popular 6-gang extension sockets up to 340mm length.

- Tidy, route & sort unsightly cable clutter
- Minimise risk of broken conductor strands
- Make socket blocks less accessible
- Prevent feet snagging cables under desks - save entanglements and costly disconnections
- Produced using electrically-safe ABS material
- Stylish & functional design. Can be used with D-Line Trunking or Zipper/Split Tube/ Spiral Wrap Accessories
- Reclaim space, so surfaces are easier to clean around
- Fully safety tested and certified to BS EN 60670-22:2006

Code	Description	Colour
EU/CTULGEB/SW	(L) 415mm x (W) 165mm x (H) 135mm	Black
EU/CTULGEW/SW	(L) 415mm x (W) 165mm x (H) 135mm	White

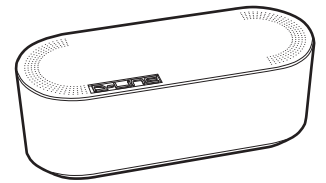

Socket Enclosures *Small*



D-Line Socket Enclosures have been used at Wembley Stadium to contain 800+ extension blocks & cable clutter on solid floors below till points

D-Line Socket Enclosures (aka Cable Tidy Units) provide a most popular solution to contain extension sockets and cable spaghetti. The stylish design can blend in modern offices and around I.T. and AV equipment. 3x rear cable entry/exit slots enable cables to be routed to left-side, right-side or vertical.

Fully safety tested, and produced from electrically-safe robust ABS material with an effective click-lock lid, these Socket Enclosures sort unsightly cables and contribute to a positive Health & Safety culture.

Use small unit to contain popular 4-gang extension sockets up to 280mm length.

- Tidy, route & sort unsightly cable clutter
- Minimise risk of broken conductor strands
- Make socket blocks less accessible
- Prevent feet snagging cables under desks - save entanglements and costly disconnections
- Produced using electrically-safe ABS material
- Stylish & functional design. Can be used with D-Line Trunking or Zipper/Split Tube/ Spiral Wrap Accessories
- Reclaim space, so surfaces are easier to clean around
- Fully safety tested and certified to BS EN 60670-22:2006

Code	Description	Colour
EU/CTUSMLB/SW	(L) 325mm x (W) 125mm x (H) 115mm	Black
EU/CTUSMLW/SW	(L) 325mm x (W) 125mm x (H) 115mm	White

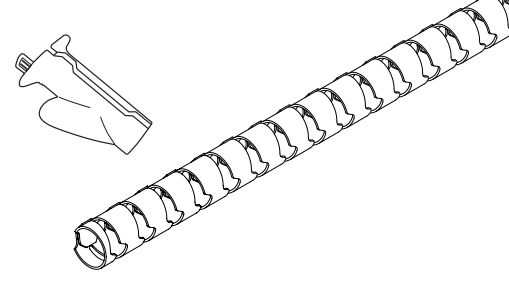

Cable Zipper

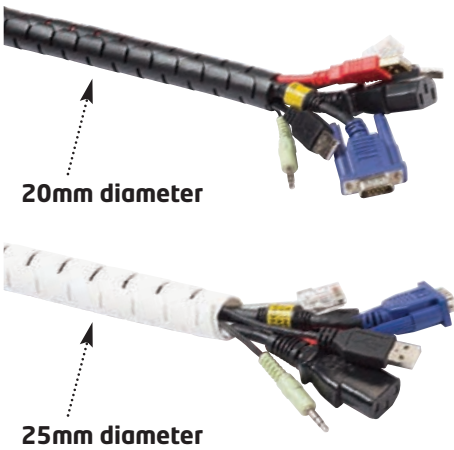

Simply place the cables in the zip tool, then pull the zip tool down along the length of the Zipper. The cables then transfer from the tool into the length of Zipper, to provide an incredibly quick and easy way to neatly organise several cables.

The cut-outs along the length enable the Zipper to bend in tight radii. The Cable Zipper is a popular solution for residential, industrial and commercial applications.

- Ideal to conceal & protect longer runs of cables
- Quick and easy to use - scissor cut to length; insert cables in zip tool; put zip tool in to length; pull zip tool along length
- Flexible design and good resistance to oils/lubricants, acids & alkalis - suitable for use around plant and machinery too
- Zip tool included in pack
- Operating temperature -30°C to +85°C

Code	Description	Colour
CZ202.5B	(L) 2.5m 20mm diameter	Black
CZ252.5B	(L) 2.5m 25mm diameter	Black
CZ202.5W	(L) 2.5m 20mm diameter	White
CZ252.5W	(L) 2.5m 25mm diameter	White
CZ2010B	(L) 10m 20mm diameter	Black
CZ2510B	(L) 10m 25mm diameter	Black
CZ2010W	(L) 10m 20mm diameter	White
CZ2510W	(L) 10m 25mm diameter	White

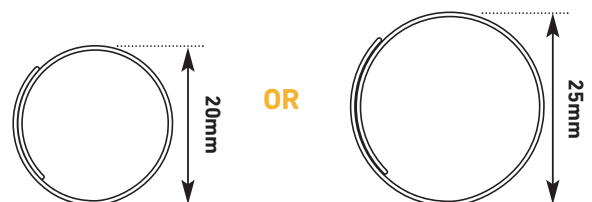

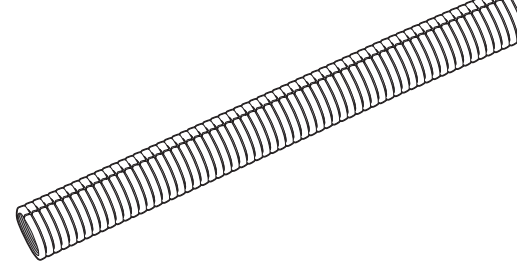

Split Cable Tube

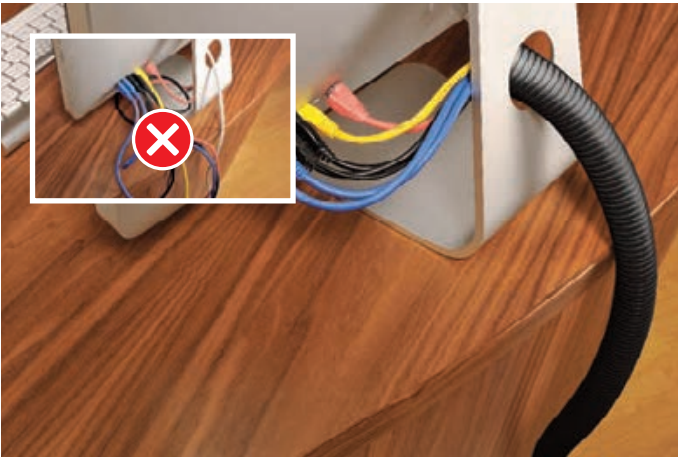

Cables can be manually inserted into Split Cable Tube to offer a neat way of organising a cluster of cables.

The 1.1m (3ft 7") length is ideal to sort cables dropping behind desks and TVs.

The LDPE material is very user-friendly to handle, and makes it easy to later add or remove cables.

- Tidy & protect several cables
- Ideal to contain cables dropping behind TVs and desks
- Pre-split - fits around existing cables
- Flexible & easiest to add or remove cables
- No application tool needed
- Supplied 6x 1.1m lengths per pack
- Fully safety tested and certified to EN 60695-2-11: 2014

Code	Description	Colour
CTT1.1/25B/6	(L) 1.1m 25mm diameter	Black
CTT1.1B/6	(L) 1.1m 32mm diameter	Black
CTT1.1/25W/6	(L) 1.1m 25mm diameter	White
CTT1.1W/6	(L) 1.1m 32mm diameter	White

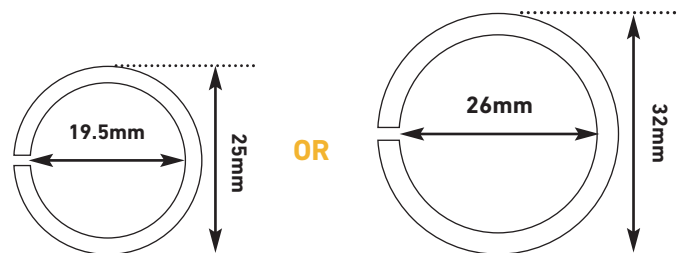

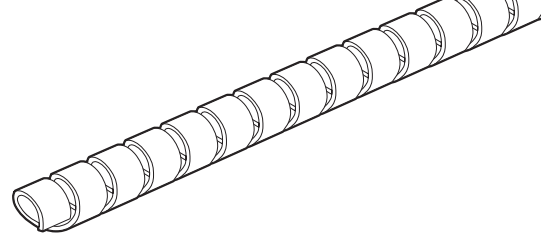

Cable Spiral Wrap

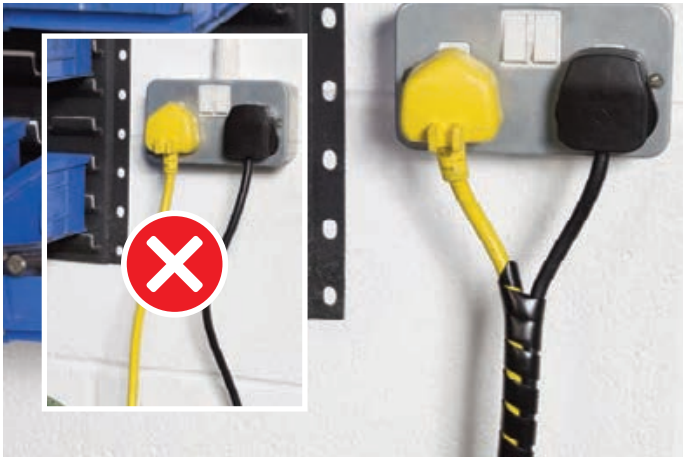

Cable Spiral Wrap is available in 2 sizes; the larger 10mm width version can expand to contain bundles of cables up to 40mm diameter; the smaller 6mm width version can expand to contain bundles of cables up to 20mm diameter.

Users simply wrap the Spiral around cables to give effective protection to cables.

This versatile solution allows cables to enter or exit along the length, so making a popular option for use in tight spaces.

- Versatile, easy to exit cables at any point along length
- Ideal for shorter runs of cable
- 1.5mm gauge LDPE material protects cable insulation
- Expands around bundles of cables up to 40mm diameter
- Good resistance to oils/lubricants, acids & alkalis
- Easy to cut to required length, then wrap by hand
- Fully safety tested and certified to EN 60695-2-11: 2014

Code	Description	Colour
CTW2.5B	(L) 2.5m 10mm - 40mm diameter	Black
CTW2.5W	(L) 2.5m 10mm - 40mm diameter	White
CTW3B	(L) 3m 6mm - 20mm diameter	Black

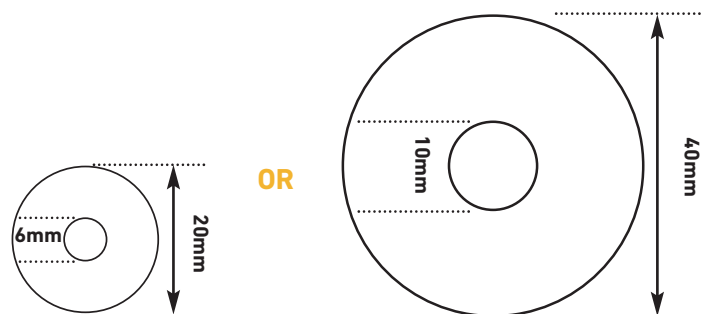



Cable Bases

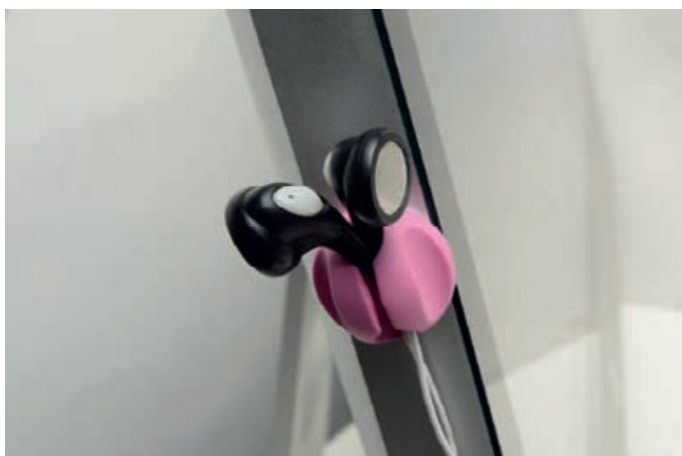

Use Cable Tidy Bases to keep cables handy and in-reach, saving any need to pick-up fallen cables!

Simply peel and stick to adhere Bases to smooth surfaces. They can hold in place cable(s), or other essentials up to 8mm diameter.

Available in a variety of colours, Cable Tidy Bases make a stylish way to keep cables and chargers where you want.

- Self-adhesive - simply peel & stick
- Save time retrieving dropped cables
- Unique user-friendly design
- Multi-purpose - use with cables, headphones, pens & pencils etc

Code	Description	Colour
CTBASEBLK	27mm diameter	Black
CTBASEWHT	27mm diameter	White
CTBASEGRY	27mm diameter	Grey
CTBASEPNK	27mm diameter	Pink
CTBASEYLW	27mm diameter	Yellow
CTBASEGRN	27mm diameter	Green
CTBASEBLU	27mm diameter	Blue



Cable Tidy Clips

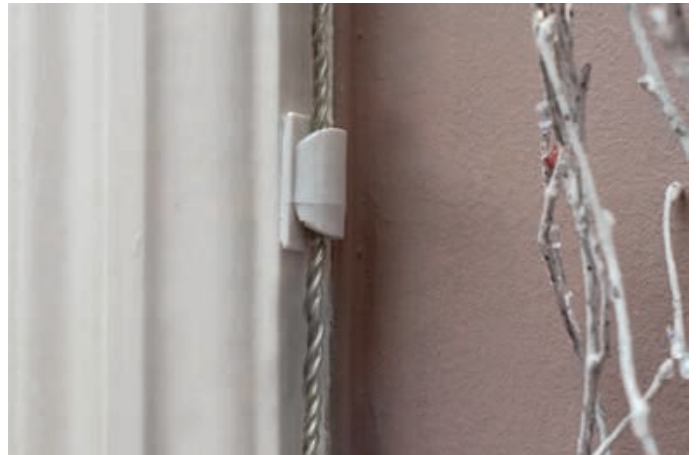
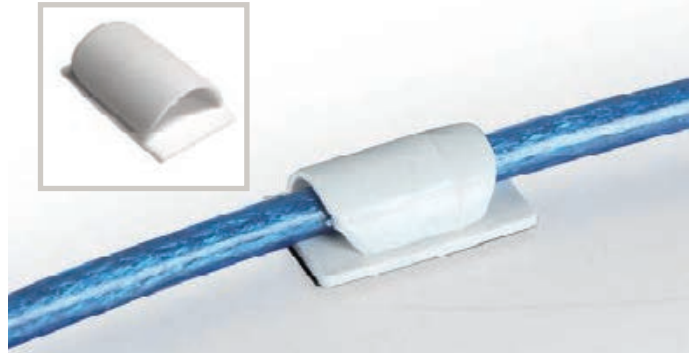

Cable Tidy Clips have a low-profile design, being only 15mm width x 8mm depth – giving a smart appearance which can be ideal for tight spaces (and door frames for example).

The self-adhesive clips are produced in UK, using a flexible PVC that makes it easy to add or remove cables.

Users can simply pull back the top cover to insert cables up to 7mm outer diameter, then release the cover to hold the cables.

- Self-adhesive PVC clips
- Keep cables in place
- Neat & low profile design
- Narrow base provides a versatile solution

Code	Description	Colour
CTCLIP20PK	(L) 26mm x (W) 15mm x (H) 8mm	White (Pack of 20)

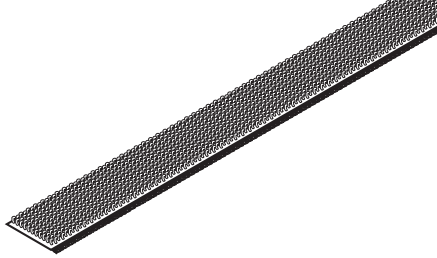

Cable Band



While commonly used as a reusable cable tie to secure cables to supports, this versatile hook & loop Band is ideal for multi-purpose applications.

Fully safety-tested, Cable Tidy Band can hold up to 10kg when fastened with 50mm overlap.

A tight bind can be achieved to make a neat solution.

Being 1.2m long enables users to cut strips to required lengths.

- Tested to hold up to 10kg with a 50mm overlap
- Hook & loop design
- Scissor cut as required; Re-usable
- Versatile 1.2m length

Code	Description
HLBAND1.2B	(L)1.2m x (W) 20mm



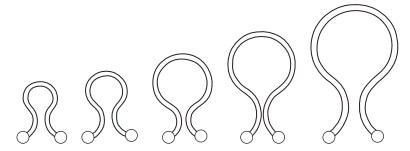

Cable Tidy Twists

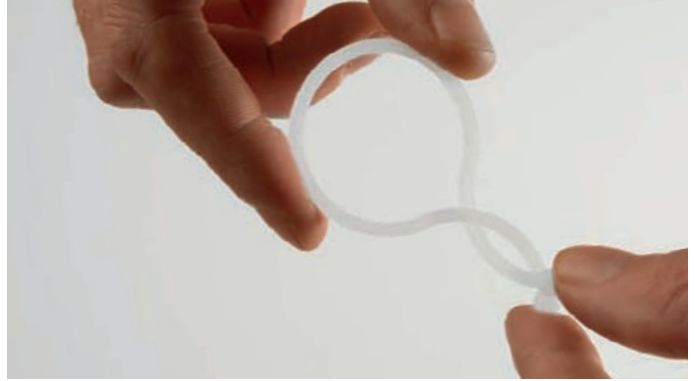
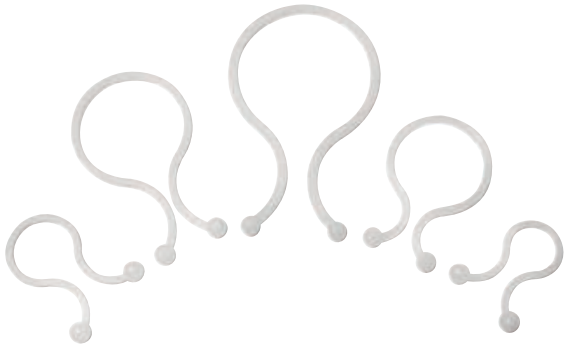

Cable Tidy Twists provide an effective way to gather several cables.

Popular applications include fastening cables to uprights, and organising cables when on the move... so saving any need later to sort or untangle the wires.

Choose from 5x alternative sizes according to the diameter required.

These Cable Tidy Twists are easy to lock and unlock, so can be used many times over.

- Simply twist & lock to fasten bundles of cables
- 5x alternative sizes for different cable bundle diameters
- Multi-purpose for use around offices and workplaces, or in transit

Code	Description	Colour
CTWST/TL450	11mm diameter	White (Pack of 100)
CTWST/TL600	15mm diameter	White (Pack of 100)
CTWST/TL950	22mm diameter	White (Pack of 100)
CTWST/TL1125	28mm diameter	White (Pack of 100)
CTWST/TL1375	35mm diameter	White (Pack of 100)

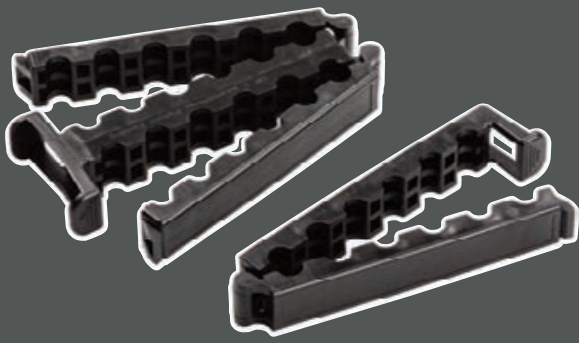

About Speed-D Clamps

Simple, effective network cable management

In busy server cabinets, patented Speed-D Clamps uniquely align rows of network cables - to potentially save a fortune in time, disruption & lost revenue!

The hinge-design of these cable organisers enables the user to open the jaws, to insert cables in the same order as the corresponding ports, before simply click-lock closing the Clamp.

By organising the cables in an orderly line-up, in event of a switch change there is no confusing which cable fits in which port. By eliminating mis-patching, critical downtime is minimised. Speed-D Clamps are a neat way also to sort cables around desks and TVs... wherever you want to tidy several cables!

“Clamping the cables in order removes ‘what goes where?’ queries to eliminate patching errors, so reducing critical downtime. Then there’s the added benefits of improved airflow and a neat appearance”

- Reduces downtime - eliminates mis-patching
- Removes human error - mitigates risk
- Simplifies documentation & labelling
- Suitable for CAT 5 & CAT 6 cables, up to 7.5mm diameter

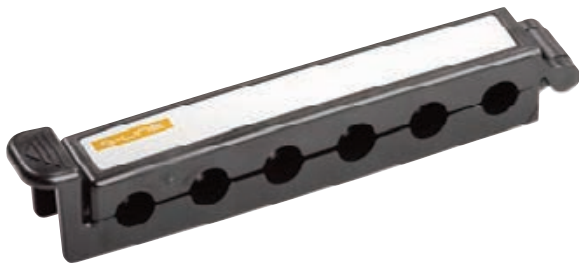

Speed-D Clamp - 6 Port



Speed-D Clamp - 12 Port

“ A long-overdue innovation that we now insist are fitted in every cabinet as a standard ”

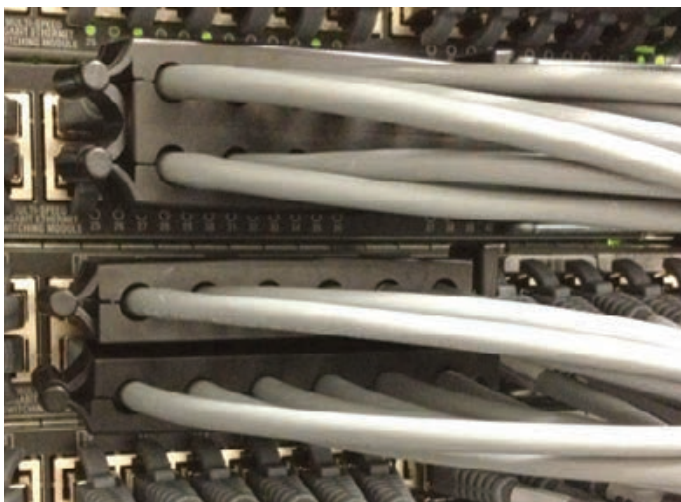

Produced from High Density PE material (HDPE). Packs include adhesive labels (to write on for identification)

Supplied in packs of 10

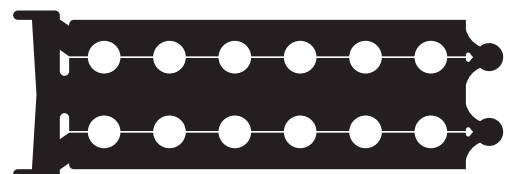

Supplied in packs of 10



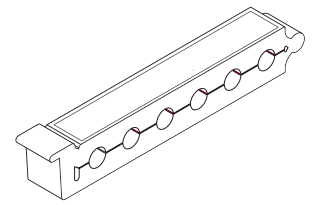

Speed-D Clamp 6 Port - Pack of 10

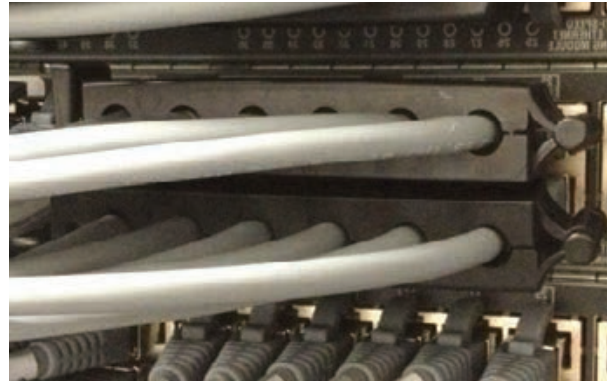

Label your clamps accordingly

Install on cabling as required

Remove cables with clamps in place

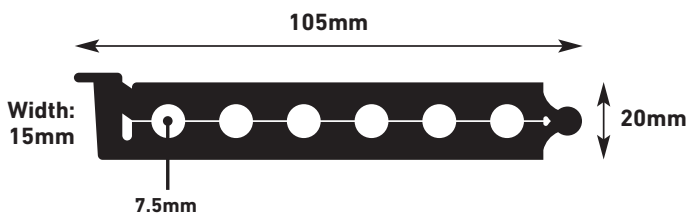

- Produced from High Density PE material (HDPE)
- Packs include adhesive labels (to write on for identification)
- Reduces downtime - eliminates mis-patching
- Removes human error - mitigates risk
- Simplifies documentation & labelling
- Suitable for CAT 5 & CAT 6 cables, up to 7.5mm diameter

Code	Description
SD6P/10	(L) 105mm x (W) 15mm x (H) 20mm Supplied with adhesive labels



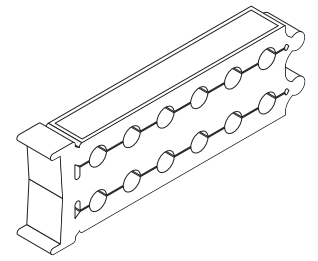

Speed-D Clamp 12 Port - Pack of 10

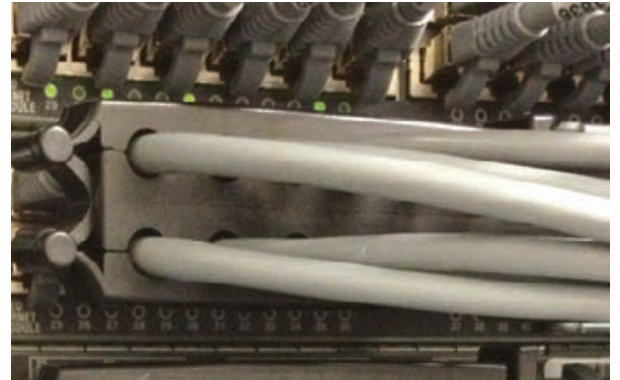

Label your clamps accordingly

Install on cabling as required

Remove cables with clamps in place

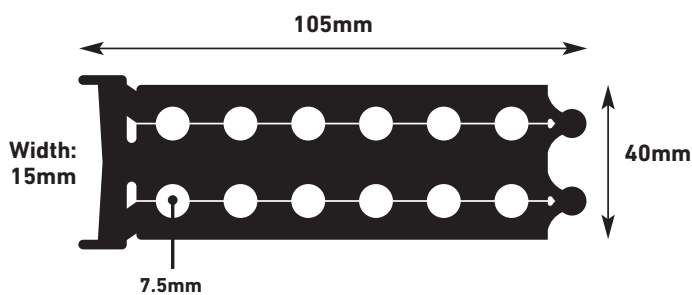

- Produced from High Density PE material (HDPE)
- Packs include adhesive labels (to write on for identification)
- Reduces downtime - eliminates mis-patching
- Removes human error - mitigates risk
- Simplifies documentation & labelling
- Suitable for CAT 5 & CAT 6 cables, up to 7.5mm diameter

Code

Description

SD12P/10 (L) 105mm x (W) 15mm x (H) 40mm Supplied with adhesive labels

